

IBM**Systems Reference Library****IBM System/360 Component Description****2400-Series Magnetic Tape Units,
2803/2804 Tape Controls, and
2816 Switching Unit, Model 1**

This manual contains a comprehensive presentation of the characteristics, functions, and features of the IBM 2400-Series Magnetic Tape Units, 2803/2804 Tape Controls, and a general description of the IBM 2816 Model 1 Switching Unit. The 2400-series consists of the 2401, 2402, and 2420 Magnetic Tape Units, and 2403, 2404, and 2415 Magnetic Tape Units and Controls.

In most instances, operational descriptions are limited to the channel and command level. Operating functions and procedures common and fundamental to all I/O operations are described in *IBM System/360 Principles of Operation*, Form A22-6821.

Subjects covered include magnetic tape unit principles; keys and lights; tape load, unload, and cleaning procedures; status and sense information; magnetic tape handling; tape block and reel organization; and error recovery procedures.



Preface

The terms "2400 series" or "2400 Magnetic Tape Units" used in this manual refer to the 2401, 2402 Models 1-6 and 2420, Model 7 Magnetic Tape Units; 2403, 2415 Models 1, 2, 3, and 4, 5, 6 Magnetic Tape Units and Controls; and 2404 Models 1, 2, and 3 Magnetic Tape Units and Controls. The information in this manual applies to all these under the title of 2400 Tape Units unless otherwise stated. All statements refer to basic models unless qualified to include special features. Statements that refer to NRZI operations refer to 2401-2404 Models 1-3 and 2415 Models 1-3 (which always operate in the NRZI mode), and to 2401-2403 Models 4-6 and 2415 Models 4-6 when operating in the NRZI mode. Statements that refer to PE operations refer to 2401-2403 Models 4-6, 2415 Models 4-6, and 2420 Model 7, because only these tape units can operate in the PE mode.

Fifth Edition (September 1968)

This is a major revision of, and obsoletes A22-6866-3 and Technical Newsletter N22-0261. This manual has been entirely rewritten to include the new 2420 tape unit. Other changes to the text, and small changes to illustrations, are marked by a vertical line to the left of the change; changed or added illustrations are denoted by the symbol ● to the left of the caption.

Changes are periodically made to the specifications herein; any such changes will be reported in subsequent revisions or Technical Newsletters.

Requests for copies of IBM publications should be made to your IBM representative or to the IBM branch office serving your locality.

This manual was prepared by the IBM Systems Development Division, Product Publications, Dept. 265, P. O. Box 1900, Boulder, Colo. 80302. A form is provided at the back of this publication for readers' comments. If the form has been removed, comments may be sent to the above address.

Magnetic Tape Unit Principles	1	2400 Tape Unit Keys and Lights	35
Magnetic Tape	1	Operator Keys—2401-2404 All Models	35
Writing and Reading Magnetic Tape	1	Operator Lights—2401-2404 All Models	36
Tape Markers	4	Operator Keys—2415 All Models	36
File Protection Device	4	Operator Lights—2415 All Models	37
Tape Blocks	5	Operator Keys—2420 Model 7	38
Checking Tape Validity	6	Operator Lights—2420 Model 7	38
2400 Magnetic Tape Units and Controls	9	Tape Handling and Organization	40
2400 Tape Operation	10	Magnetic Tape Handling	40
Read	11	Machine Room Housekeeping	40
Read Backward	11	Damage Prevention	40
Write	11	Retest Service for Magnetic Tape	41
Control	11	Tape Library Records	42
Sense	15	 	
I/O Instructions	15	Appendix A Procedures	44
2400 Features	15	Tape Load Procedure—2401-2404	44
Seven-Track Feature	15	Tape Unload Procedure—2401-2404	44
Data Conversion Feature	18	2400 Tape Transport Cleaning Procedure	45
Dual Density Feature	20	Tape Load Procedure—2415	46
Nine-Track (800 bpi NRZI) Compatibility Feature	21	Tape UnLoad Procedure—2415	46
Mode Compatability Feature	21	Tape Load Procedure—2420	47
Seven- and Nine-Track (800 bpi NRZI) Compatibility Feature	21	Tape UnLoad Procedure—2420	48
2415 Compatibility Features	21	AC and DC Power Distribution	48
Status Information and Sense Data	21	Power Off/Power On—2400 Units	48
Status Information	21	2401 Magnetic Tape Unit	48
Sense Data	22	2402 Magnetic Tape Unit	48
 		2403 and 2404 Magnetic Tape Units and Controls	48
2404/2804 Simultaneous Tape Control	28	2400 Tape Timings	49
Simultaneous Control Programming Aids	29	2400 Tape Error Recovery Procedures (ERPs)	49
 		General Characteristics	49
IBM 2816 Switching Unit Model 1	32	Operational Characteristic Requirements	49
Functional Operation	32	Operational Characteristic Requirements—Model 20	53
Operator Panel	33	 	
Switches	33	Appendix B 2420 Cartridge and Reel Specifications	54
Lights	33	Optional Tape Cartridge for Use with the 2420 Model 7 Tape Unit	54
Indicators	33	Tape Reel Considerations for 2420 Wraparound Cartridge Use	54

Illustrations

<u>Figure</u>	<u>Title</u>	<u>Page</u>	<u>Figure</u>	<u>Title</u>	<u>Page</u>
1	Magnetic Tape Reel	12	22	Data Conversion—Data Converter On	20
2	Section of IBM Magnetic Tape	1	23	Data Field Conversion Adjustment	20
3	2400 Tape Path	2	24	2401-2404 Special Features Configurator	27
4	Two Gap Read/Write Head	3	25	Simultaneous Read-Write Control Unit	28
5	Nine-Track and Seven-Track Tape Data Format	3	26	IBM 2816 Switching Unit Model 1	32
6	Reflective Tape Markers	4	27	2816 Switching Unit Model 1 Configurators	33
7	File Protect Ring	5	28	2816 Operator Panel	34
8	Tape Blocks	5	29	2401-2404 Operator Panel	35
9	Organization of Blocks on Tape	6	30	2415 Operator Panel	37
●10	CRC and LRC Byte Positions in NRZI Tape Format	8	31	2420 Operator Panel	38
11	Error Correction and Tape Checks Summarized	8	32	Sample File History Form	42
12	2400 Magnetic Tape Unit Characteristics	9	33	Sample Reel History Form	42
13	IBM 729/7330 and 2400 Recording Track Width	9	34	Sample Tape Available Form	43
14	Magnetic Tape Unit Command Code Format	12	35	2401-2404 Tape Transport—Model 1 or 4	44
15	Effects of Tape Markers on the Program	14	36	2401-2404 Tape Transport—Model 2, 3, 5 and 6	45
16	Extended Binary Coded Decimal Interchange Code	16	37	2415 Tape Transport—Model 1-6	47
17	Eight-Bit Representation for USASCII-8	16	38	Tape Unit Cleaning Intervals	47
18	Translation Chart—EBCDIC to BCDIC	17	39	2400 Series Tape Unit Timing Charts	50
19	Magnetic Tape Code for BCDIC	18	●40	Status and Sense Indicator (Bits) Checking Sequence	51
20	Standard BCD Interchange Code and Graphics	19	41	Status and Sense Indicator (Bits) Checking Sequence—Model 20	53
21	Data Translation—Translator Off and Converter Off	20	42	Reel Specifications for Use in the 2420 Wraparound Cartridge	55

2803 Model 1 or 2

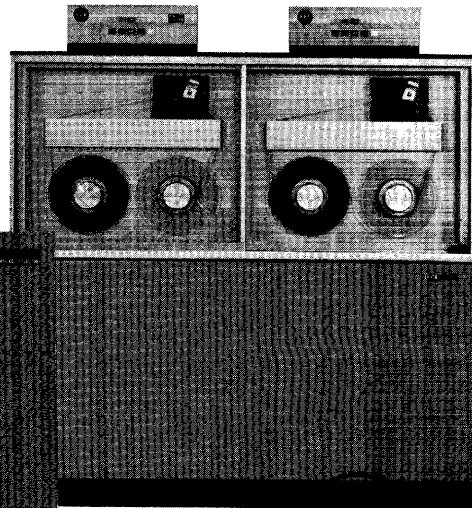

2415 Model 1 or 4

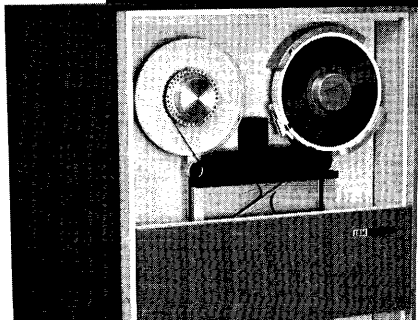
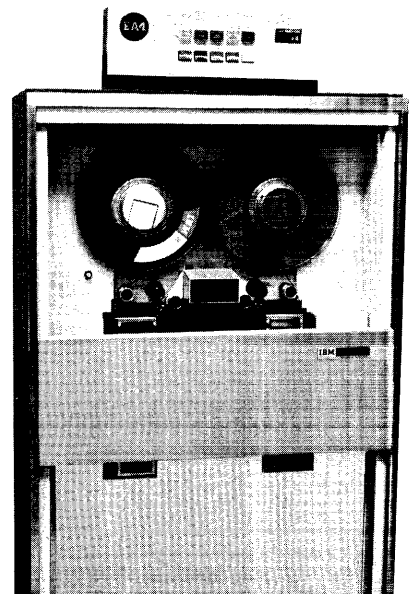
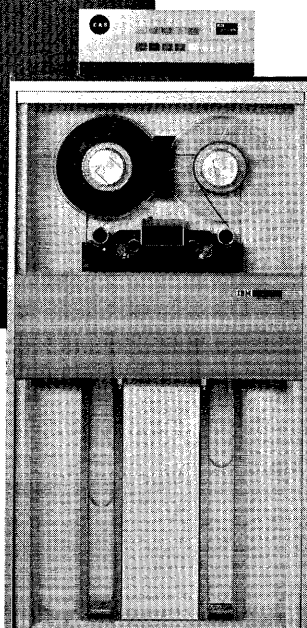
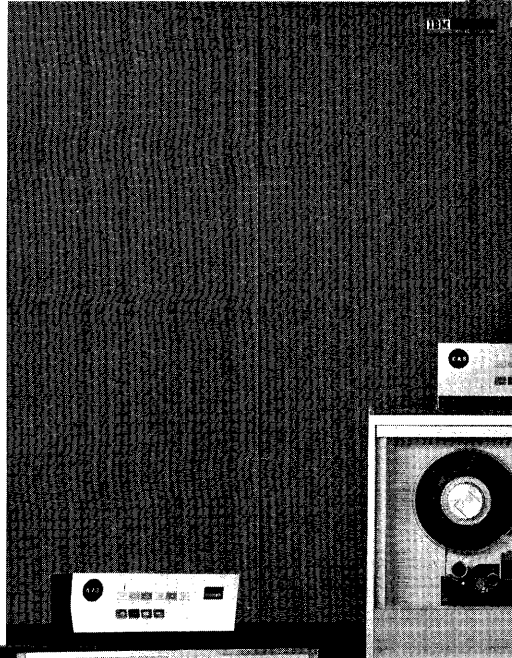

IBM magnetic tape units function in the system as both input and output devices. They transport the magnetic tape and read and write the information, as directed by the data processing system. The different models of the IBM 2400 tape units are similar in general appearance and operational use; the principal differences are the speed at which the units transport tape, and the rate and manner of recording information on tape.

MAGNETIC TAPE

Magnetic tape is extensively used as an input/output medium in data processing systems. It is also used for storing intermediate results of computations and for storage of large files of data.

IBM 2400 Magnetic Tape Units read or write data on 1/2-inch wide magnetic tape. IBM Series/500, or Dynexcel tape, is recommended for 1600 bpi operation. Equivalents of the above IBM tapes or IBM Heavy Duty (HD) and its equivalents may also be used. IBM Mylar* cannot be used on the 2420 tape unit. Magnetic tape for all tape units is wound on plastic reels 10-1/2 inches in diameter (Figure 1). A full reel contains approximately 2,400 feet of usable tape, but lengths as short as 50 feet can be used.

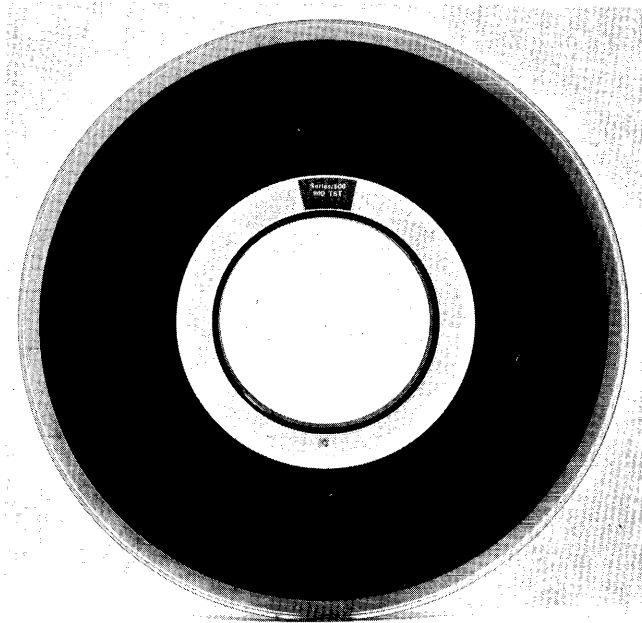

Figure 1. Magnetic Tape Reel

*Trademark of E.I. Dupont de Nemours & Co. (Inc)

A full reel weighs about four pounds, and can contain data (4,800 bytes/block) equivalent to that in 480,000 cards punched in all 80 columns. A miniature reel, 8-1/2 inches in diameter, is available that holds 1,200 feet of tape.

IBM magnetic tape (Figure 2) is similar to the tape used in home tape recorders. To produce this magnetic tape, microscopically small particles of iron oxide are mixed with a binding agent and uniformly applied to the surface of long strips of flexible plastic. The plastic base is about as thick as cigarette paper; the magnetic coating is about one-third that thick. Recording occurs in this ferromagnetic coating.

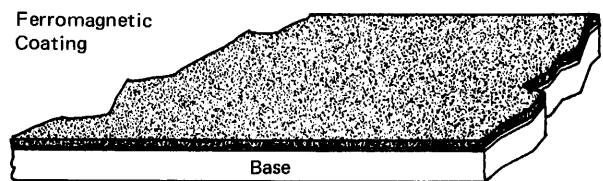

Figure 2. Section of IBM Magnetic Tape

After the magnetic layer hardens, the strips are slit into 1/2-inch ribbons, wound on reels, and tested. Untested tape can be used for many types of magnetic recordings, but the magnetic tape used for data processing must be of particularly high quality. Tiny flaws, which would not interfere with the recording of music, could prevent the accurate recording of data. Small imperfections that result in lost data can cause an entire series of computations to be repeated—a waste of valuable machine time.

WRITING AND READING MAGNETIC TAPE

Figure 3 shows the arrangement of reels and tape on IBM 2400 Magnetic Tape Units. The tape reels and head are accessible by opening the reel door. When the door is open, an interlock switch automatically prevents operation of the drive motors.

The 2420 tape unit is an automatic threading machine with the file (machine) reel located on the left side and the read/write head assembly located between vertical vacuum columns.

The read/write head assembly, located between the vacuum columns in the 2401-2404 tape units, is built in two sections. The lower section is stationary, and the

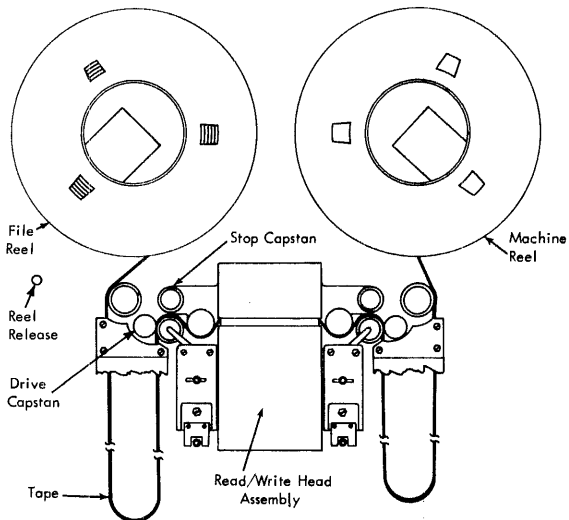

2401 - 2404 Models 2, 3 and 5, 6 Tape Transport

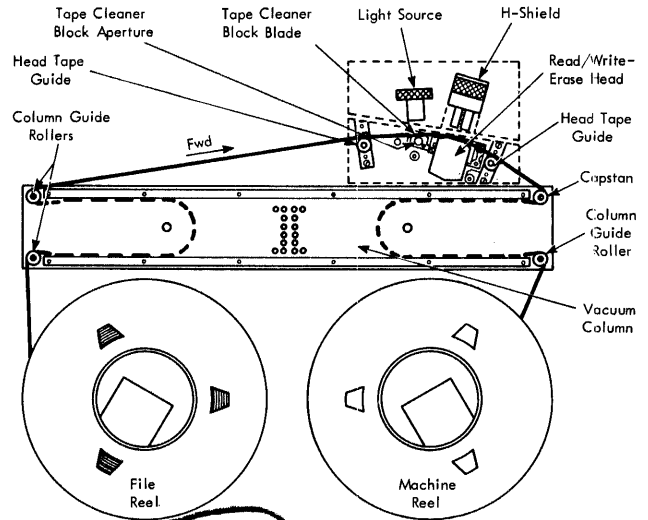

2415 Models 1 - 6 Tape Transport

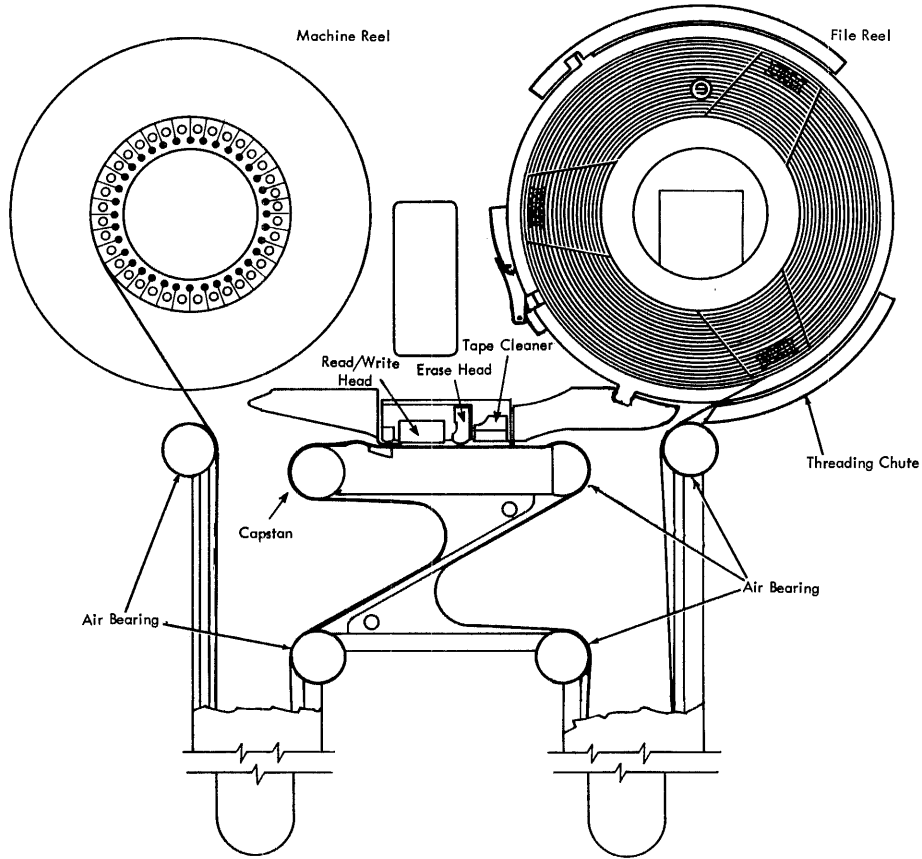

2420 Model 7 Tape Transport

Figure 3. 2400 Tape Path

upper section can be moved up or down under control of the tape-unit keys. When the upper section is up, the operator can thread tape. When down, the tape is brought in contact with the head for reading or writing.

The 2415 read/write head, located above the vacuum column, is a stationary, one-section assembly. The H-shield, immediately above the head assembly, moves up and down. The operator must manually push the H-shield up before threading tape; he must push it back down to allow reading and writing of tape.

Tape moves from the file reel through the left vacuum column (right column on the 2420 TU), across the read/write head, through the right vacuum column (left column on the 2420 TU), to the machine reel. The loop in each vacuum column acts as a buffer for the sudden start and stop motion of the tape. Vacuum-actuated switches in the columns control motors/brakes that permit the two reels to rotate independently. Tape may be backspaced over a tape block (formerly called tape record) or rewound to the beginning of the reel. Reading, but not writing, may take place while tape is moving backward.

Before tape reaches the read/write head, it passes an erase head. During a write operation, current flows in the erase head coil to erase previously written information.

Writing or reading of tape information occurs as the tape is moved across the read/write head (Figure 4). Writing occurs at the write gap portion, and reading occurs at the read gap portion of the read/write head.

Information is written on tape by magnetizing small discrete areas in nine parallel channels or tracks (nine-track read/write head) or in seven parallel channels or tracks (seven-track read/write head). The magnetized spots or bits in the nine- and seven-track positions across the width of the tape produce a column of bits (Figure 5). Tape information becomes a series of bit columns along the length of the tape. The significance of a column of bits depends on the code. For example, in nine-track operation, each column of bits is called byte and can represent a character, two digits, or part of a word of data. When data is recorded on tape in seven-bit binary coded decimal form, each column of bits represents a BCD character. In binary form, this same column of bits is part of a word of data and not considered a character.

Each block written is read back by the two-gap read/write head and checked in the tape control. See 'Checking Tape Validity.'

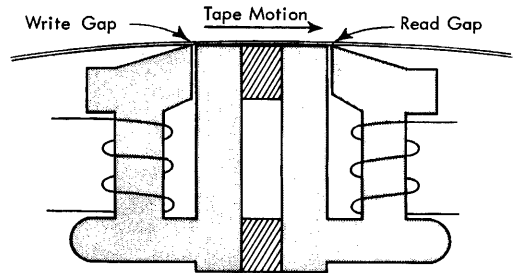

Figure 4. Two Gap Read/Write Head

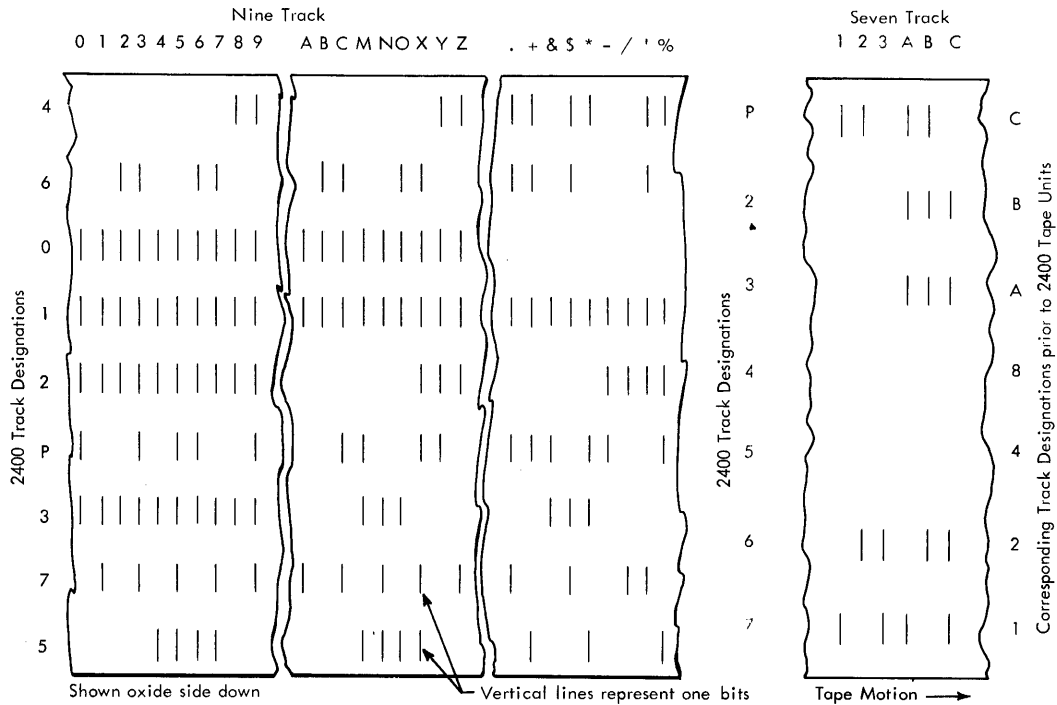

Figure 5. Nine-Track and Seven-Track Tape Data Format

Models 1, 2, and 3 of the 2400 tape units use the non-return-to-zero IBM (NRZI) method of recording information on tape; Models 4, 5, and 6 (and 2420 Model 7) use phase encoding. In NRZI recording, only one bits are recorded as magnetized spots on tape. In phase encoding, both zero and one bits are recorded as magnetized spots. The zero and the one-bit are opposite in polarity. The method of recording both zero and one-bits allows distinction between zero-bits and no recording. An improved writing check, and independent track decoding with less critical skew requirements provide optimum performance and reliability at higher data rates.

TAPE MARKERS

Magnetic tape must have some blank space at the beginning and end of the reel to allow threading through the feed mechanism of the tape unit. Markers called reflective strips (Figure 6) are placed on the tape by the operator to enable the tape unit to sense the beginning and the end of the usable portion of tape. The tape unit senses the markers as either the load point marker, where reading or writing is to begin, or as the end-of-tape marker, approximately where writing is to stop.

The markers are small pieces of transparent plastic with a thin film of aluminum on one side. Pressure-sensitive adhesive covers the aluminum film. The markers are fastened manually to the base (uncoated) side of the tape. New reels of tape obtained from IBM have these markers in position.

Load Point Marker: At least 10 feet of tape must be allowed between the beginning of the reel and the load point marker as a leader for threading the tape on the tape unit. More than 10 feet may be allowed by placing the marker at any desired distance from the beginning of the reel. To indicate the load point, the marker must be parallel to and not more than 1/32 inch from the edge of the tape nearest the operator when the reel is mounted. See unit check under "Unit Status Byte." For the 2420 Tape Unit see "Tape Load Procedure—2420" in Appendix A.

End-of-Tape Marker: About 14 feet of tape are usually reserved between the end-of-tape marker and the end of the tape. This space includes at least 10 feet of leader and four feet for the recording of data after the end-of-tape marker is sensed. When the tape is mounted, the marker is placed parallel to and not more than 1/32 inch from the edge of the tape nearest the tape unit.

The end-of-tape reflective marker indicates the beginning of the end-of-tape area. Sensing the end-of-tape reflective marker during any forward operation turns on the tape indicate light on the operator's panel. A write, write tape mark, or erase gap operation coincident with

TI on sets unit exception, bit 7, in the unit status byte. Executing any backward operation may turn off TI. See Figure 15, unit exception under "Unit Status Byte," and tape indicate under "Operator Lights."

Note: Because these markers are photo-electrically sensed, intense light sources (sunlight, flashbulbs, etc.) may cause machine malfunctions.

FILE PROTECTION DEVICE

Because the writing operation automatically erases any previous information on the tape, a file protection device is provided to prevent accidental erasure. A plastic "write-enable" ring (Figure 7) fits in a circular groove molded in the back (machine side) of the tape reel. This ring must be in place to enable the machine to write on the tape in the reel. (No ring-no write.) When the ring is removed, only reading can take place; the file is protected from accidental writing, which could erase valuable information. When a tape unit is file protected, the file protect light on the operator's panel is lighted.

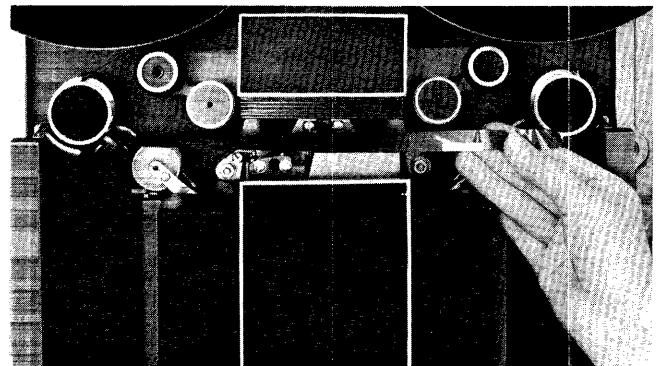

Load Point Marker

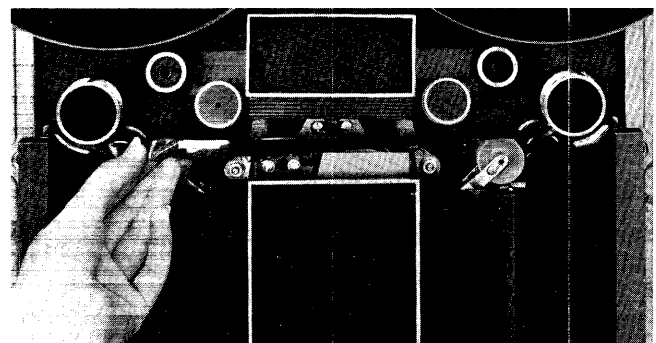

End-of-Tape Marker

Figure 6. Reflective Tape Markers

Note: To ensure that file protection is effective in 2415 tape units, tape must always be unloaded and the file reel demounted for removal of the file protection ring. This is necessary to effect proper interlocking of the write circuitry. The described procedure should be followed for all tape units to avert physical damage to tapes when inserting or removing the file protection ring.

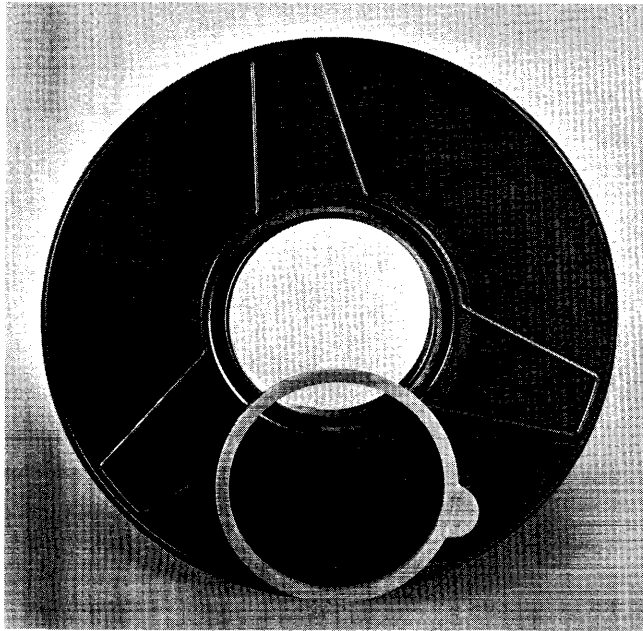

Figure 7. File Protect Ring

TAPE BLOCKS

Information on tape is arranged in blocks (Figure 8). A tape block may consist of one or more records, which are the logical units of data. Blocks are separated on tape by an interblock gap—a length of blank tape approximately 0.75 inch long for tape written in seven tracks, and approximately 0.6 inch for tape written in nine tracks (see “2400 Tape Timings”). During writing, the gap is automatically produced at the end of a block. A tape block is therefore defined or marked by an interblock gap before and after the block (Figure 8).

Programming Note: Blocks of any practical size (18 bytes or larger) may be written. The maximum size is usually limited only by the capacity of data storage area in the computer. Minimum block lengths are 12 bytes for a read operation and 18 bytes for a write operation. This minimum length was established to distinguish noise blocks from data blocks. There is no machine check for compliance with this minimum length. There is a program check for minimum block length in error recovery procedures (see Appendix A) only when a data check occurs during a read operation. An action in these procedures may cause a block of less than 12 bytes to be bypassed.

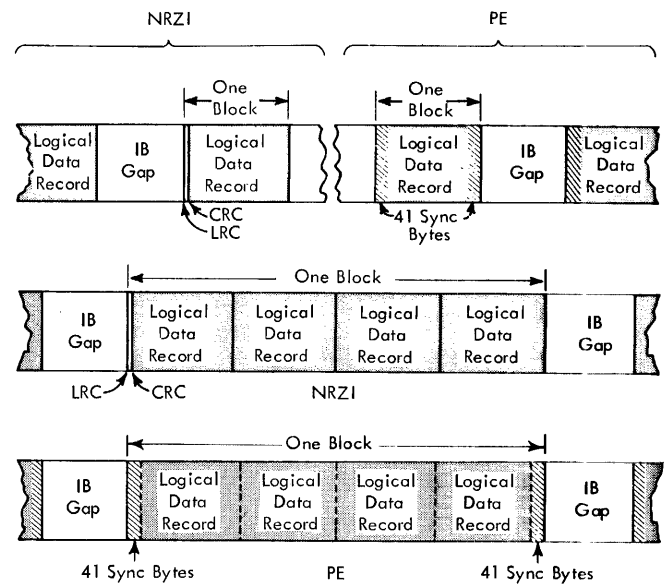

Figure 8. Tape Blocks

When a defective block is read, more bytes than were written may be transferred into core. Therefore, if the CCW count is larger than the buffer areas used to receive data, the buffer area may overflow and destroy adjacent data. Therefore, the channel command word count should not exceed the buffer area.

The makeup of a PE-recorded tape block is different from the NRZI recorded tape block. Besides data, the NRZI block contains the cyclic redundancy check (CRC) and the longitudinal redundancy check (LRC) characters (bytes). The PE block contains 41 synchronizing bytes immediately before and after the data bytes. The tape control formats sync bytes. CRC, LRC or 41. See Figure 8 and Figure 10.

Reading an NRZI-recorded tape block begins with the first byte sensed after a gap and continues until the next gap is reached; reading a PE-recorded block begins with the first byte of data following the 41 sync bytes and continues until the trailing sync bytes are recognized. Neither the NRZI check characters nor the PE synchronizing bytes are sent to the channel during a read operation; they are present specifically to facilitate the reading or writing of correct data.

Tape Mark: The end of a file of information is indicated by a tape mark—a special block written only by the write tape mark command. One or more files may be written on a reel of tape.

In the NRZI format, the tape mark is a special single byte block; in the PE format, it is a multibyte control block. In either case, the tape mark follows a gap approximately 3.75 inches (5.5 inches for the 2420 Model 7). See Figure 9.

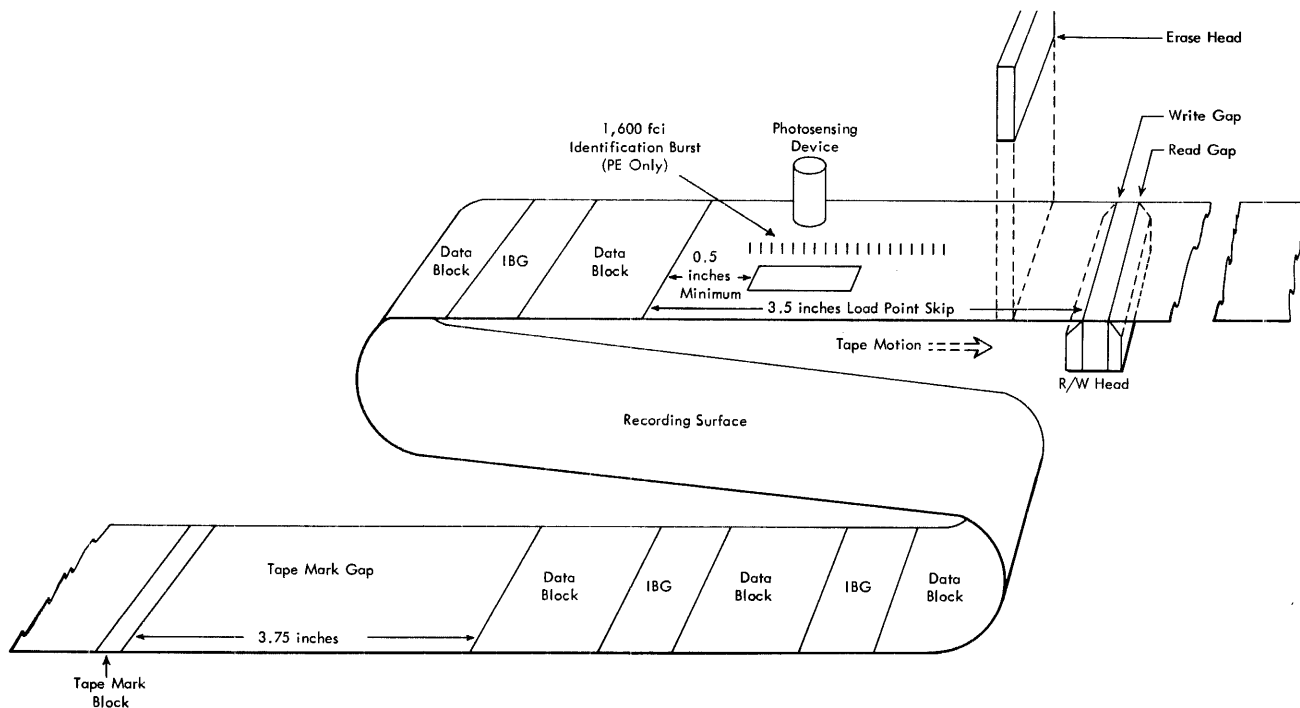

Figure 9. Organization of Blocks on Tape

Note: Tape marks read in the wrong density in NRZI may give unit exception and/or unit check indications. For example: reading a tape mark at 800 bpi which was originally written at 200 bpi.

CHECKING TAPE VALIDITY

Tape units that use NRZI recording utilize the longitudinal, vertical, cyclic redundancy (nine-track only), and skew checks to insure the validity of information written on or read from tape. Tape units that use PE recording utilize the vertical redundancy, envelope, multiple track error, and skew checks. (See Figure 11 and "Sense Byte Three.")

The checking of tape information is accomplished during a read operation or during a read back check of a write operation. Validity errors detected during a write operation should result in a programmed rewrite; validity errors detected during a read operation result in either automatic error correction (PE), or, when detected by the program, should result in a programmed reread for correction (NRZI and PE). See "2400 Tape Error Recovery Procedures."

Longitudinal Redundancy Check—LRC (NRZI)

The longitudinal redundancy check monitors all tracks to

ensure the presence of an even number of one bits in each track. As the tape block is written, an odd or even indication of the number of one bits in each data track is automatically determined for each tape block. A check bit is written at the end of each track having an odd number of bits; the total number of bits in the track, including the check bit, is now even. The vertical combination of these longitudinal check bits makes up the longitudinal check character.

When tape is read, either in the read back check of a write operation or in a read operation, the same odd-even indication is determined for each data track, including any bits of the longitudinal check character generated during the write operation. If any track indicated an odd number of bits, an LRC error is indicated. The LRC check is effective during write, write tape mark, read, and read backward operations.

Vertical Redundancy Check—VRC (NRZI)

The vertical redundancy or parity check provides a means of checking for the proper number of one bits in each byte. The P-track on tape (Figure 5) contains the parity or check bit for those bytes that otherwise would not conform to the parity mode. During a read or read backward operation, or during a write or write tape mark operation, each column of bits across the width of the

tape is checked for an even number of bits while operating in even-parity mode, and checked for an odd number of bits while operating in odd-parity mode. (Nine-track tape is always recorded in odd parity.) If the number of bits for each byte does not correspond to the parity mode involved, a VRC error is indicated. The means used to indicate a VRC error is not the same for both read and write operations. (See "Sense Byte Three.") A VRC and/or LRC error may also be caused by noise during an erase gap operation (except the 2415).

Both LRC and VRC errors cause data check to be set and a resultant unit check to be indicated in the unit status byte. (See "Status Information" and "Sense Data.")

Vertical Redundancy Check/Envelope Check/Multiple Track Error (PE)

During a write operation, vertical parity (P) bits are recorded along with the data bits, and a signal amplitude check is performed on each track. Vertical redundancy is checked for the 2420, but a weak signal is indicated by setting envelope check in the sense data for all models. A tape velocity check is also maintained. If an abnormal change in velocity occurs, multiple-track error (MTE) is set in the sense data. If either envelope check or multiple track error is set, the program should provide for rewriting the block.

During the read operation, vertical parity is checked and signal amplitude is monitored. If a weak signal in a single track and a parity error occur, automatic error correction is effected; rereading of the block is unnecessary, and a VRC error is not indicated. If a VRC error occurs without a corresponding weak signal, the VRC error is indicated. If weak signals are detected in two or more tracks, MTE is set in the sense data. With either VRC or MTE errors, data check and unit check are also indicated (see "Status Information and Sense Data"). The program should then provide for rereading the block.

Cyclic Redundancy Check—CRC (NRZI)

CRC is utilized by 2401-2404 Models 1-3 tape units and by 2401-2403 Models 4-6 while operating in the 800 bpi, nine-track NRZI mode. In NRZI mode, the 2415 also writes the appropriate CRC byte after each block. However, CRC is ignored in the 2415 read operation; that is, it is not used for error checking and correction. The CRC is written only to maintain compatibility with the 2401-2404 tape units that write 800 bpi NRZI tape.

The cyclic redundancy check is effective only in nine-track read and read backward operations, and serves as a means to correct single-track read errors. As a block is written, a special check character (CRC character) is automatically calculated from the data bytes. The CRC character is written after the body of the block (excepting the tape mark block) and before the LRC character

(Figure 10). During a read operation, the CRC character is again calculated and compared with the written CRC character. If an error exists, a CRC error is indicated, and an error pattern character is calculated by using read/write VRC indications and their positions within the block. When the CRC error and data checks are indicated in the sense data, unit check is set in the unit status byte that is sent to the channel in the ending status (see "Status Information and Sense Data"). The track-in-error is identified in byte 2 of the sense data. Any single track with errors is identified by the corresponding bit set to 1. For example, errors in track 3 cause sense byte 2 to be set:

```
P 0 1 2 3 4 5 6 7
  0 0 0 0 1 0 0 0 0
```

If, however, a multiple-track error is the cause of the CRC error indication, no track-in-error determination can be made, and sense byte 2 is set:

```
P 0 1 2 3 4 5 6 7
  1 0 0 0 0 0 0 1 1
```

Single-track errors may be corrected by implementing an error correction routine; multiple-track errors cannot be corrected. Subsequent rereading of the block with a multiple-track error may, however, result in a correctable single-track error or no error at all. Following detection of a CRC error, the error correction programming procedure is implemented. Essentially, the error procedure results in correcting single-track read errors, reducing multiple-track errors to correctable single-track errors, or indicating multiple-track permanent read errors.

CRC error correction is given in Appendix A of this manual.

Skew Check

During an NRZI write, write tape mark, or erase operation, bytes are sensed for excessive skew (vertical bit alignment of byte) in the skew register. If excessive skew occurs, a skew error is indicated. Tape units that use PE recording check skew during the read operation.

Drive and Tape Compatibility Check

A burst of bits at load point (Figure 9) in the P-track of 1,600 bpi tape indicates to a Model 4, 5, or 6 tape unit that it is reading 1,600 bpi tape (bit 5, byte 3 in sense data is set to 1). The lack of this burst of bits indicates that the tape was recorded at a density of 800 bpi. Models 4, 5, and 6 with the dual density feature may also read (and write) 800 bpi tape.

Models 1, 2, and 3 do not check tape compatibility; with a nine-track head, they read/write only 800 bpi tape.

Figure 11 presents a summary of the tape checks used by 2400 tape units.

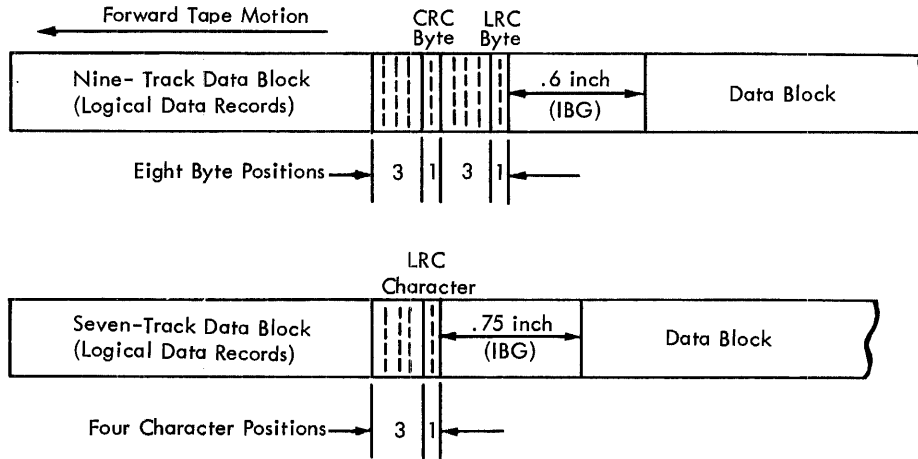

● Figure 10. CRC and LRC Byte Positions in NRZI Tape Format

Recording	Tape Checking Used								
	Tape Unit	Single-Track Error Correction	Longitudinal Redundancy Check	Vertical Redundancy Check	Cyclic Redundancy Check	Envelope Check	Multiple Track Error Check	Skew Check	Drive-Tape Compatibility
N R Z I	2401-4 Models 1-3 9-Track	R (Programmed)	R,W	R,W	R			W	
	2401-4 Models 1-3 7-Track		R,W	R,W				W	
	2415 Models 1-6 9-Track		R,W	R,W	*			W	
	2415 Models 1-6 7-Track		R,W	R,W				W	
	2401-3 Models 4-6 9-Track	R (Programmed)	R,W	R,W	R			W	
P E	2401-3 Models 4-6 9-Track	R (Automatic)		R		W	R,W	R	R
	2415 Models 4-6 9-Track	R (Automatic)		R		W	R,W	R	R
	2420 Model 7 9-Track	R (Automatic)		R,W		W	R,W	R	R

* CRC byte written for 2401-2404 NRZI, compatibility purposes only.
 R Occurs during a read operation
 W Occurs during a write operation

Figure 11. Error Correction and Tape Checks Summarized

2400 Magnetic Tape Units and Controls

IBM 2400 Magnetic Tape Units read or write data on 1/2-inch wide magnetic tape. The 2400 Model 1, 2, or 3 tape unit with a nine-track read/write head (nine-track mode) reads or writes data in nine tracks along the length of the tape at a single density of 800 bytes per inch. Models 4, 5, and 6 normally read/write tape at a density of 1,600 bpi. With the addition of the dual density feature, they can read/write either 800 bpi NRZI or 1,600 bpi phase-encoding tape. The 2420 tape unit reads/writes tape in nine tracks at 1600 bpi only.

Each byte of information consists of eight data bits and a parity bit. Each byte may represent two decimal digits, eight binary bits, or one special or alphanumeric character. The various models of 2400 tape units differ in speed of tape motion and provide data rates from 3,750 to 320,000 bytes per second (bps). (See Figure 12.)

Although the 2400 tape units use a larger number of recording tracks than do the 729 or 7330 tape units (9 versus 7), the read track is 1/3 wider (Figure 13). The increased width produces a stronger read signal, one less sensitive to tape defects such as particles and creases.

A review of the IBM System/360 byte structure of data codes indicates that certain bit positions have a value of 1 much more frequently than others. Also the P-bit position is used quite frequently. To reduce the exposure to permanent read errors caused by magnetic tape edge damage, the track format on nine-track 2400 tape units is such that the most frequently used track positions are towards the center of the tape, and the least used positions towards the edges (Figure 5).

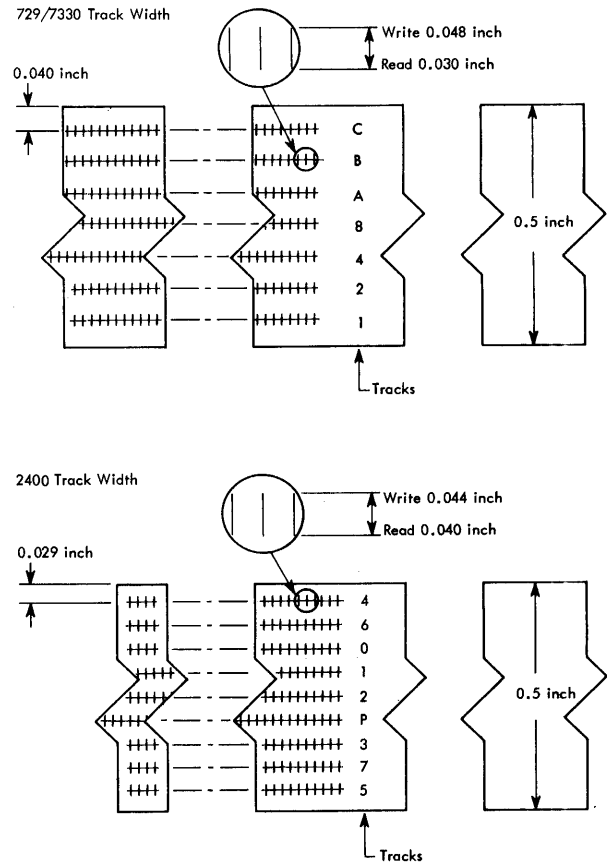

Figure 13. IBM 729/7330 and 2400 Recording Track Width

Characteristics	2401 - 2404 Tape Units							2415 Tape Units		2420 Tape Unit
	Model 1 Model 4	Model 1	Model 2 Model 5	Model 2	Model 3 Model 6	Model 3	Model 1-3 Model 4-6	Model 1-6	Model 7	
Number of Tracks and Recording Method	9-Track NRZI 9-Track PE	7-Track NRZI	9-Track NRZI 9-Track PE	7-Track NRZI	9-Track NRZI 9-Track PE	7-Track NRZI	9-Track NRZI 9-Track PE	7-Track NRZI	9-Track PE	
Density (BPI) Bytes per inch	800 1600	800 556 200	800 1600	800 556 200	800 1600	800 556 200	800 1600	800 556 200	1600	
Data Rate (Bytes/Sec)	30,000 60,000	30,000 20,850 7,500	60,000 120,000	60,000 41,700 15,000	90,000 180,000	90,000 62,500 22,500	15,000 30,000	15,000 10,425 3,750	320,000	
Tape Speed (In/Sec)	37.5 37.5	37.5	75.0 75.0	75.0	112.5 112.5	112.5	18.75 18.75	18.75	200	
Interblock Gap (Inches)	0.6 0.6	.75	0.6 0.6	.75	0.6 0.6	.75	0.6 0.6	.75	0.6	

Figure 12. 2400 Magnetic Tape Unit Characteristics

The 2400 Model 1, 2, and 3 tape units equipped with a seven-track read/write head and the optional seven-track compatibility feature, read or write magnetic tape in the IBM 729 or 7330 tape format. Such a feature establishes a data compatibility link between IBM system seven-track tape libraries and the IBM System/360. Tape densities of 200, 556, or 800 bytes per inch with odd or even parity checking is provided. Figure 12 shows 2400 tape unit characteristics for nine-track and seven-track mode operation.

The data converter, an additional option for tape units that have the seven-track compatibility feature, allows the reading or writing of seven-track binary data. This option provides, via the System/360, cross communication of binary information recorded in seven-track and nine-track format.

The following tape units and tape controls are each contained in a single frame or unit.

- IBM 2401 Magnetic Tape Unit Model 1, 2, 3, or 4, 5, 6
One magnetic tape unit
- IBM 2402 Magnetic Tape Unit Model 1, 2, 3, or 4, 5, 6
Two magnetic tape units
- IBM 2403 Magnetic Tape Unit and Control Model 1, 2, or 3
One magnetic tape unit Model 1, 2, or 3
Control for eight Model 1, 2, or 3 tape units
- IBM 2403 Magnetic Tape Unit and Control Model 4, 5, or 6
One magnetic tape unit Model 4, 5, or 6
Control for eight Model 4, 5, or 6 tape units
- IBM 2404 Magnetic Tape Unit and Control Model 1, 2, or 3
One magnetic tape unit Model 1, 2, or 3
Simultaneous read-while-write control for eight Model 1, 2, or 3 tape units
(There is no 2404 Model 4, 5, or 6)
- IBM 2803 Tape Control Model 1
Control for up to eight Model 1, 2, or 3 tape units
This is the same control as the one contained in the 1403 Model 1, 2, or 3
- IBM 2803 Tape Control Model 2
Control for up to eight Model 4, 5, or 6 tape units
This is the same control as the one contained in the 2403 Model 4, 5, or 6
- IBM 2804 Tape Control Model 1
Simultaneous read-while-write control for up to eight Model 1, 2, or 3 tape units. This is the same control as the one contained in the 2404 Model 1, 2, or 3
- IBM 2804 Tape Control Model 2
Simultaneous read-while-write control for up to eight Model 4, 5, or 6 tape units
- IBM 2415 Magnetic Tape Unit and Control
Model 1—Two 800 bpi drives and control (see "Note")
Model 2—Four 800 bpi drives and control
Model 3—Six 800 bpi drives and control
Model 4—Two 1,600 and/or 800 bpi drives and control
Model 5—Four 1,600 and/or 800 bpi drives and control
Model 6—Six 1,600 and/or 800 bpi drives and control

Note: The control contained in each 2415 may be utilized only by the drives within the model group.

- IBM 2420 Magnetic Tape Unit Model 7
One Magnetic Tape Unit.

Model numbers for the independent tape units or for integrated magnetic tape units and controls relate specifically to the tape unit. The simultaneous read-while-write control (2404 and 2804) may connect to two channels of the same system, so a read type operation on one tape unit can occur at the same time as a write type operation on a second tape unit. (See "2404/2408 Simultaneous Tape Control.")

2400 TAPE OPERATION

The CPU program initiates an I/O operation on a tape unit with the start I/O instruction. (See *IBM System/360 Principles of Operation*, Form A22-6821, for a detailed explanation of the function of 'start I/O'.) This instruction identifies the channel, tape control, and tape unit to be used and causes the channel to fetch the channel address word (CAW) from a fixed location in main storage. The CAW designates the location in main storage from which the channel subsequently fetches the first channel command word (CCW). The CCW specifies the command to be executed and the storage area, if any, to be used.

The channel, tape control, and tape unit are designated by the I/O address, which is obtained by the addition of the contents of the D₁ field and the contents of the register specified by the B₁ field of the I/O instruction. The I/O address consists of two parts: a device address in the eight low-order bit positions and a three-bit channel address. The five high-order bits of the device address identify the tape control; the three low-order bits identify the tape unit.

When the 16-drive addressing feature is installed in a 2403 or 2803 tape control, the four high-order bits of the device address identify the tape control (see "IBM 2816 Switching Unit Model 1"). The four low-order bits identify the tape unit. The assignment of the device address is arbitrary. The assignment is made at the time of installation and normally is fixed.

The command code (bit positions 0-7) of a channel command word specifies to the channel and the tape control which tape operation will be performed (Figure 14). The main storage areas used by commands that involve a transfer of data are indicated by the data address portion of the CCW. (Refer to the *System/360 Principles of Operation* for a thorough understanding of the CCW's and the channel program) *Note:* All IBM System/360 tape controls operate only in the burst mode.

Associated with each tape operation are the initial status and ending status of the addressed control and tape unit. When the program initiates an operation with start I/O, the initial status of the channel, control, and tape unit are indicated to the program by the condition code (CC) in the current PSW. The status of the control and tape unit is indicated to the channel during initial selection, and in some cases (when CC = 1) is stored by

the channel in the unit status byte of the channel status word (CSW). In such cases, the program may seek additional information concerning the conditions that caused the storing of unit status. This information is contained in the sense data (see "Sense Data").

The status of the control and/or tape unit is also indicated to the channel at the completion of the operation—this is the ending status. For a comprehensive explanation of unit status, see "Status Information and Sense Data."

Read

The selected tape unit moves tape forward to the next interblock gap and stops. Information recorded on tape is read, sent to the channel, and placed in contiguous ascending locations in main storage, starting with the address specified in the CCW.

Attempting to read NRZI-recorded tape from load point, on a tape unit capable only of PE operation, causes the tape to stop in the load point gap. Not capable is set in the sense data, and unit check is set in the unit status byte.

Reading a tape mark sets the unit exception bit of the unit status byte. Tape mark is not sent to storage when read as a special block; it is sent to storage as data if read anywhere in the body of a block.

Sensing the EOT reflective marker during the read operation turns on tape indicate, but does not set the unit exception status bit.

Read Backward

The selected tape unit moves tape backward to the next interblock gap and stops. Data read from tape is sent to the channel and placed in storage in the reverse order in which it was written. Data in storage is placed in descending order of addresses, starting with the address specified in the CCW. Reading a tape mark sets the unit exception bit of the unit status byte. Tape mark is not sent to storage when read as a special block; it is sent to storage as data if read anywhere in the body of a block. Sensing load point sets unit check.

A read backward operation terminated at load point may cause invalid data to be transferred and data check to be set. Data received while reading backward into load point is not to be considered valid, even if there is no separate data check. A seven-track read backward operation overrides, but does not reset, the data converter-on mode set. A seven-track read backward operation should not be attempted using tapes generated by other than 2400 tape units.

Note: To facilitate noise recognition, a minimum block length of 12 bytes is recommended for read and read backward operations.

Write

The selected tape unit moves tape forward, writing data fetched from main storage, starting with the address specified in the CCW. When writing magnetic tape, block length is not defined, and the amount of data written is controlled only by the count in the CCW. Every operation terminated under count control causes the incorrect length indication unless the indication is suppressed by the suppressed length indication (SLI) flag. Sensing the EOT reflective marker turns on TI, and performing a write operation in the end-of-tape area sets the unit exception bit of the unit status byte.

Note: To facilitate noise recognition, a minimum block length of 18 bytes is recommended. (To provide safety, the minimum block length is larger for write than for read. Tapes written by other than a 2400 tape unit may be read.)

Control

The control operation, as specified by the modifier bits of the command code, is initiated at the tape control and tape unit. The 2400 control operations include tape motion commands and mode set commands (Figure 14). Except for request track-in-error (TIE) (2401-2404 NRZI), they are immediate operations.

Immediate operations involve no transfer of data; they release the channel immediately by signaling channel end upon receipt of the command. Two of these commands also release the control unit to the program shortly after initiation of the command (see "Rewind" and "Rewind and Unload"). While execution of all other control commands involves both the control and the tape unit, the mode set commands (except request TIE) require no execution time beyond receipt of the command at initial selection.

Programming Note: At initial selection, a device normally responds to an immediate operation with channel end. Therefore, any errors or unusual conditions (e.g. unit check, unit exception) that occur during an immediate operation will be included in the ending status byte only.

Tape Motion Commands

Rewind (REW): The selected tape unit rewinds tape. Device end is signaled when the tape reaches load point. The control is freed and is available to the program after rewind disconnect time (see "2400 Tape Timings").

Rewind and Unload (RUN): The selected tape unit rewinds tape to load point and automatically unloads. (The rewinding and unloading of tape is not performed in the same order in all models.) Ending status, including device end, control unit end, and unit check is signaled when the tape control portion of the command is completed, i.e., at the end of rewind-unload disconnect time (see "2400

Command Code Format	0	1	2	3	4	5	6	7
Write	0	0	0	0	0	0	0	1
Read	0	0	0	0	0	0	1	0
Read Backward	0	0	0	0	1	1	0	0
Sense	0	0	0	0	0	1	0	0
Control	0	0	C	C	C	1	1	1 (Tape motion operation)
	D	D	M	M	M	0	1	1 (Seven-track mode setting operation)
	1	1	N	N	N	0	1	1 (Nine-track mode setting operation - Models 4-6. NOP for Models 1-3.)

C	C	C (Control Code)	N	N	N	D	D (Density Set) -- Seven-Track Operation Only
0	0	0 = Rewind (REW)	0	0	0	0	0 = 200 bpi
0	0	1 = Rewind and Unload (RUN)	0	0	1	0	1 = 556 bpi
0	1	0 = Erase Gap (ERG)	0	0	1	1	0 = 800 bpi Reset condition
0	1	1 = Write Tape Mark (WTM)				1	1 = Set Nine-Track Mode - Models 4-6
1	0	0 = Backspace Block (BSB)					
1	0	1 = Backspace File (BSF)					
1	1	0 = Forward Space Block (FSB)					
1	1	1 = Forward Space File (FSF)					

NOTE: Other bit patterns in this group reserved for future use.

Note: Nine-track operation overrides but does not reset a seven track mode setting. Seven-track operation overrides but does not reset a nine-track mode setting. Nine-track operations on Models 1, 2,3 force 800 bpi and odd parity.

M	M	M (Mode Modifiers)	Set Density	Set Odd Parity	Set Even Parity	Data Converter On (Note 4)	Data Converter Off	Translator On	Translator Off	Request TIE (Note 3)
0	0	0 -----								
0	0	1 -----								
0	1	0 -----	X	X		X			X	
0	1	1 -----								X
1	0	0 -----	X		X		X		X	
1	0	1 -----	X		X		X	X		
1	1	0 -----	X	X			X		X	
1	1	1 -----	X	X			X	X		

NOP (No Operation)
Reserved for Diagnostic use ONLY.

Reset Cond (Note 1)

Nine-track NRZI only -Note 5

Reset Cond (Note 2)

- X = Condition set on or activated by related mode modifier bit configuration.
- Notes:
- Reset condition if data converter feature is installed with the seven-track feature. This command will be rejected by control units that have the seven-track feature, but do not have the data converter feature installed. Density, add parity, and translator off will be set.
 - Reset condition if data converter feature is not installed with the seven-track feature.
 - TIE - Track in error
 - A read backward command overrides data converter on mode set.
 - Request TIE Issued to a Model 4, 5, 6 PE, 2420 Model 7, or 2415 results in NOP.

Figure 14. Magnetic Tape Unit Command Code Format

Tape Timings”). The tape control is made available to the program at this time, and the tape unit proceeds with the rewind-unload. Device end is again indicated when the operator reloads the tape unit, presses the start key, and the tape unit goes from not ready to ready.

Erase Gap (ERG): The selected tape unit moves tape forward, erasing tape for a distance of approximately 3-1/2 inches. Performing this operation in the end-of-tape (EOT) area sets the unit exception bit of the unit status byte.

Write Tape Mark (WTM): The selected tape unit writes a tape mark (a special block) on tape. Performing this operation in the end-of-tape area sets the unit exception bit of the unit status byte.

Note: Only the WTM command should be used to write a tape mark on tape.

Forward Space Block (FSB): The selected tape unit moves tape forward to the next interblock gap. No data is transferred to the channel and main storage. Sensing a tape mark sets the unit exception bit of the unit status byte.

Forward Space File (FSF): The selected tape unit moves tape forward to the interblock gap beyond the next mark. No data is transferred. Sensing the tape mark does not set the unit exception bit of the unit status byte.

Programming Note: A tape mark must be read in the same density in which it was written.

Backspace Block (BSB): The selected tape unit moves tape backward to the nearest interblock gap or to load point, whichever comes first. No data is transferred. Sensing a tape mark sets the unit exception bit of the unit status byte. Sensing load point sets unit check.

Programming Note: It is common practice to check the header label on a reel of tape before writing on it. If a scratch tape has been “stripped,” that is, a section has been cut off the leading end, the new load point marker was probably placed within data and no header label is present; therefore, a data check may occur as the tape leaves load point. The normal ensuing backspace to return tape to load point results in a unit check. This type of error on a write “open” should be ignored.

Backspace File (BSF): The selected tape unit moves tape backward to the interblock gap beyond the next tape mark or to load point, whichever comes first. No data is transferred. Sensing load point sets unit check. Sensing the tape mark does not set the unit exception bit of the unit status byte.

Note: Certain blocks can be erroneously identified as tape marks during seven-track backward operations. If a tape block satisfies the following three conditions, it is possible for the block to be recognized as a tape mark during a back-space-block or back-space-file operation:

1. The block was written at 800 bpi.
2. The block contains less than five bytes.
3. The combination of the bit structures of all the bytes comprises a tape mark.

Programs that comply with tape programming standards (which have defined the minimum length block) will not normally encounter these conditions, and therefore, would not need to verify the tape mark. For programs where the possibility is known to exist, the tape mark should be verified by reading forward. If verification is not successful, program intervention is required unless other program means to verify the tape location are used.

Programming Note: Figure 15 summarizes the effects on the program produced by encountering load point (LP), tape mark (TM), or end-of-tape (EOT) during any of the various tape operations. The following abbreviations are used in Figure 15: UE (unit exception), UC (unit check), TI (tape indicate), CUE (control unit end), and DE (device end).

Programming Note: Tape controls (including 2415) have no interlocking to prevent the execution of improper sequences of write and read type operations that may result in writing bits or leaving partial blocks on tape. Avoiding these non-permissible sequences is a program responsibility.

Avoid the following two basic sequences:

1. Write type operation after forward read type operation except as defined below:
 - A. A block or TM read is known to be followed by a TM.
 - B. A block or TM read is known to have been followed by ERG when written or known to have been the last block written before a backward operation.
example: R R W# avoid.
W B R W # allowed.
2. Read forward type operation following write type operations.
example: RBWR# avoid.
WBRR # avoid.

W indicates write type operation; write, write TM, or ERG.

R indicates forward read type operation; read, forward space, or forward space file.

B indicates backward type operation; read backward, backspace, or backspace file.

indicates the logical record on which problems may occur.

Tape Operation	Load Point (LP) Reflective Marker	Tape Mark	End-of-Tape (EOT) Reflective Marker (See Note)
Write	Sense byte 1, bit 4 set while tape at LP	No indication	TI turned on, UE set in unit status byte
Read	Sense byte 1, bit 4 set while tape at LP	UE set in unit status byte	TI turned on, no indication in status byte
Read Backward	UC set in unit status byte; data check possible - See "IBM 2400 Tape Operation -- Read Backward"	UE set in unit status byte	TI turned off (Anywhere in EOT area for 2401-2404 Models 1, 2, and 3) (If EOT is sensed for 2401-2403 Models 4, 5, & 6; for 2420 Model 7; and for 2415 all Models). See Note
Rewind (Program or Manual)	See "Write"	No indication	Turns off TI
Rewind-Unload (Program or Manual)	UC, DE, and CUE set in unit status byte upon completion of control unit portion of operation	No indication	Turns off TI
Erase Gap	See "Write"	No indication	TI turned on, UE set in unit status byte
Write Tape Mark	See "Write"	No indication	TI turned on, UE set in unit status byte
Forward Space Block	See "Read"	UE set in unit status byte	Turns on TI (No indication in status byte)
Forward Space File	See "Read"	No indication	Turns on TI (No indication in status byte)
Back Space Block	UC set in unit status byte	UE set in unit status byte	Turns off TI (Anywhere in EOT area for 2401-2404 Models 1, 2, and 3) (If EOT is sensed for 2401-2403 Models 4, 5, & 6; for 2420 Model 7; and for 2415 all Models). See Note
Back Space File	UC set in unit status byte	No indication	Turns off TI (Anywhere in EOT area for 2401-2404 Models 1, 2, and 3) (If EOT is sensed for 2401-2403 Models 4, 5, & 6; for 2420 Model 7; and for 2415 all Models). See Note

NOTES: 2401-2404 Models 1-3: Successive forward operation after first TI setting will repeat unit exception unless a backward-type command is given (See ERP).

2401-2403 Models 4-6;
2415 All Models;

2420 Model 7: Successive forward operation after first TI setting will repeat unit exception.

Figure 15. Effects of Tape Markers on The Program

Because it may be difficult or impossible to insure the above safe situations in a general programming case, the use of a write after read forward sequence should be confined to situations where strict control of format and command sequence exists.

Write is allowable following a backspace. Assume the following tape format with labels where * is used to denote TM: VOL HDR * DATA SET * EOF * HDR * DATA SET * EOF * * A rewrite of the last data set involves the following safe and proper sequence: After processing the next to last EOF and TM, read forward to verify HDR label of the last data set, backspace, write new HDR, rewrite data set. If a new data set were being added, the read forward verifies the second consecutive TM, and thus, the true end of a data sets on this tape. A backspace, write new HDR, etc., completes the sequence.

Mode Set Commands

Mode set commands are used to select density, parity, data converter, and code translator for seven-track operation. These commands are also used to request track-in-error information in 2401-2404 nine-track NRZI operation, and to select a recording mode for 2400 nine-track Models 4-6. Models of 2400 tape units that are equipped with the seven-track read/write head (see "Seven-Track Feature") always operate in the seven-track mode, and respond to the seven-track mode setting control commands (Figure 14).

The mode modifier bits (2, 3, and 4 of the command byte) define the mode. The specific seven-track mode of operation is determined by the combination of the following conditions:

Set Density: Tape control is set to operate at the density indicated by the density-set-bits (0, 1) of the command.

Set Odd Parity: Tape operation is executed as odd parity.

Set Even Parity: Tape operation is executed as even parity.

Data Converter On: Data converter to be used.

Data Converter Off: Data converter not to be used.

Translator On: Translator to be used.

Translator Off: Translator not to be used.

The mode modifiers for parity, translator, and data converter apply only to seven-track operation. Once the seven-track mode is set it applies to all seven-track drives on the control unit. It need not be set again unless it is desired to change mode.

Normally, 2400 tape units are equipped with nine-track read/write heads and always operate in the nine-track mode. The 2401-2404 (NRZI) tape units that write tape at 800 bpi utilize only the NOP and request TIE mode set commands. (See cyclic redundancy check under "Checking Tape Validity.") The 2400 tape units that have

the dual density capability use mode set commands to set a recording mode of either 800 bpi (NRZI) or 1,600 bpi (PE) (Figure 14). The mode setting is retained by the control unit and is set in any Model 4-6 tape unit when a write type operation is performed at load point. The tape unit retains the setting until its tape is returned to load point. Unless reset, the control unit's mode setting remains until changed by another mode set command.

Because Models 1-3 nine-track tape units write only at the 800 bpi density, and Models 4-6 tape units without the dual density feature write only at the 1,600 bpi density, a mode set command is not necessary before writing tape on these units. In this case, the density setting in the control has no effect on the write operation nor is any indication given to the program if the write density and the mode set density do not agree.

Once set, the modes within the tape control remain set unless changed or reset. Nine-track and seven-track mode setting are independent and have no effect upon each other. Pressing the system reset key sets the seven-track mode to 800 bpi with data converter on (if this feature is present), translator off, and odd parity. This key also sets the nine-track mode to 1,600 bpi in the control for Models 4-6 but produces no effect in the control for Models 1-3 nine-track tape units.

Sense

Sense data is transferred from the selected tape and control units via the channel to main storage. The transfer rate for sense data is determined by the interface timings and is normally much faster than the transfer rate for a read or write operation. The sense data is placed in storage, starting with the address specified in the OCW. (See "Sense Data.")

A sense command addressed to a not-ready tape unit is executed and device end is signaled with channel end. A second device end is signaled when the tape unit becomes ready unless tape control power was dropped.

I/O Instructions

In addition to initiating one of the five I/O operations by means of 'start I/O,' the program can cause certain actions at the tape control by using the 'test I/O' and 'halt I/O' instructions:

Test I/O: The 'test I/O' instruction performed by the CPU causes the status byte for the selected tape unit to be sent to the channel for analysis. No actual operation is performed.

Halt I/O: 'Halt I/O' causes data transfer to stop. The control unit disconnects from the channel and proceeds independently to the completion of the operation. When the operation is completed, the control unit tries to reestablish connection with the channel to transfer ending

status. If addressed, the control unit appears busy while performing a command.

If a 'halt I/O' is executed before transfer of the first byte of data during a write operation, the operation is cancelled, and channel end, device end, unit check, and word count zero are generated.

2400 FEATURES

Seven-Track Feature

The seven-track feature enables the 2400 tape units in System/360 to process tape compatible with other IBM computers that utilize such tape units as the 727, 729, or 7330; these tape units read and write tape in the BCD or binary format. To implement this feature, a seven-track read/write head is installed in the 2400 tape unit, replacing the nine-track read/write head, and the seven-track compatibility feature is installed in the control unit. (The control is then capable of operating with both seven- and nine-track tape units.) Reading or writing may be done at densities of 200, 556, or 800 bytes per inch. Odd or even parity checking is provided. Interblock gaps are approximately 0.75 inch. Character density and type of parity checking are selected by the modifier bits in the mode set command byte (Figure 14).

The translator of the seven-track compatibility feature is bidirectional; when set on, it translates eight-bit bytes from main storage to six-bit BCD tape characters, and translates six-bit BCD tape characters to eight-bit bytes for main storage. Each main storage byte becomes a tape character, and vice versa. The translator is set on or off by a mode set control command (Figure 14).

Figures 16 and 17 show the 256 byte configurations and the associated graphics for the Extended Binary Coded Decimal Interchange Code (EBCDIC) and the United States of American Standard Code for Information Interchange (USASCII) extended to eight bits. Figure 18 shows the same 256 byte configurations of codes as shown in Figures 16 and 17, but with a six-bit BCD tape code graphic (standard BCD interchange code).

The translator is a part of the seven-track compatibility or a part of the seven-track portion of the seven- and nine-track (800 bpi NRZI) compatibility feature. When using this translator, data rates for each tape unit are not changed, and there are no changes in the tape unit's general characteristics.

Tape controls with the basic seven-track optional feature contain a device which translates between a BCDIC (Binary Coded Decimal Interchange Code) subset of EBCDIC (Extended BCD Interchange Code) and BCDIC (See Figure 18). The translator is activated by a mode set command. See Figure 14 and mode modifiers.

Bit Positions		00				01				10				11				Bit Positions	
		00	01	10	11	00	01	10	11	00	01	10	11	00	01	10	11		
00	00	NUL		DS		SP	&	-									0		
	01			SOS			/										1		
	10			FS						a	i						2		
	11		TM							b	k	s						3	
01	00	PF	RES	BYP	PN					d	m	u					4		
	01	HT	NL	LF	RS					e	n	v					5		
	10	LC	BS	EOB	UC					f	o	w					6		
	11	DEL	IL	PRE	EOT					g	p	x						7	
10	00																		
	01																		
	10		CC	SM		¢	!		:										
	11					.	\$,	#										
11	00					<	*	%	@										
	01					()	-	'										
	10					+	;	>	=										
	11						_	?	"										

Example: A is represented by bit configuration 11 00 00 01

- NOTE: 1. Graphic representations are undefined for the bit-patterns outside the heavily-outlined portions of the chart. These bit-patterns are referred to as undefined graphic bit-patterns.
2. If an undefined graphic bit-pattern is sent from main storage to the tape unit, the seven-track bit-pattern that will be recorded by the tape unit is not specified.
3. The bit-pattern recorded by the tape unit for an undefined graphic bit-pattern sent from main storage may be different from that recorded by other devices.
4. IBM reserves the right to change at any time the seven-track bit-pattern recorded by the 2400 tape unit for an undefined graphic bit-pattern sent from main storage.

Figure 16. Extended Binary Coded Decimal Interchange Code

Bit Positions		00				01				10				11				Bit Positions	
		00	01	10	11	00	01	10	11	00	01	10	11	00	01	10	11		
00	00	NUL	DLE			SP	0					@	P				P		
	01	SOH	DC1			!	1					A	Q			a	q		
	10	STX	DC2			"	2					B	R			b	r		
	11	ETX	DC3			#	3						C	S			c	s	
01	00	EOT	DC4			\$	4					D	T			d	t		
	01	ENQ	NAK			%	5					E	U			e	u		
	10	ACK	SYN			&	6					F	V			f	v		
	11	BEL	ETB			'	7						G	W			g	w	
10	00	BS	CAN			(8						H	X			h	x	
	01	HT	EM)	9						I	Y			i	y	
	10	LF	SS			*	:						J	Z			j	z	
	11	VT	ESC			+	;							K	[k	{
11	00	FF	FS			,	<							L	\			l	
	01	CR	GS			-	=							M]			m	}
	10	SO	RS			.	>							N	^			n	~
	11	SI	US			/	?								O	_			o

Figure 17. Eight-Bit Representation for USASCII - 8

Bit Positions 4,5 6,7		00				01				10				11				Bit Positions					
		00		01		10		11		00		01		10		11		← 0,1	← 2,3				
		0	1	2	3	4	5	6	7	8	9	A	B	C	D	E	F						
00	00	0						SP ₀₀	& ₀₆	- ₁₂								0	25	35	45	54	
	01	1								/ ₁₃						A ₂₆	J ₃₆		1	26	36		55
	10	2														B ₂₇	K ₃₇	S ₄₆	2	27	37	46	56
	11	3														C ₂₈	L ₃₈	T ₄₇	3	28	38	47	57
01	00	4														D ₂₉	M ₃₉	U ₄₈	4	29	39	48	58
	01	5														E ₃₀	N ₄₀	V ₄₉	5	30	40	49	59
	10	6														F ₃₁	O ₄₁	W ₅₀	6	31	41	50	60
	11	7														G ₃₂	P ₄₂	X ₅₁	7	32	42	51	61
10	00	8														H ₃₃	Q ₄₃	Y ₅₂	8	33	43	52	62
	01	9														I ₃₄	R ₄₄	Z ₅₃	9	34	44	53	63
	10	A																					
	11	B																					
11	00	C																					
	01	D																					
	10	E																					
	11	F																					

NOTES:

- Graphic representations are not defined in System/360 for collating numbers 25, 35, 45 of the seven-track subset.
- If any CPU bit pattern other than those indicated by collating number on this chart is sent from main storage to a seven-track tape unit, the seven-track bit pattern that will be recorded by the tape unit is not specified.
- The bit-pattern recorded by the seven-track tape unit for a code other than that indicated on this chart sent from main storage may be different from that recorded by other devices.
- IBM reserves the right to change at any time the bit-pattern recorded by the 2400 seven-track tape unit for a code other than that on this chart.
- Graphic representations for collating numbers 02, 03, 04, 05, 09, 11, 16, 17, 18, 19, 22, 23, 24 are not the same as EBCDIC.
- In writing even parity seven-track code, both collating numbers 00 and 19 become the BCD Substitute Blank (C-A----). In reading even parity seven-track code this blank becomes collating number 00.

Figure 18. Translation Chart – EBCDIC to BCDIC

The BCD Interchange Code is shown in Figure 20. Using collating numbers from Figure 20, the seven-track tape code in binary table form is shown in Figure 19, omitting those graphics not consistent with defined EBCDIC graphics. To translate an eight-bit byte included in the BCDIC subset, locate the eight-bit byte configuration in Figure 18. The collating number then defines the seven-track BCD tape code in either Figure 19 or 20. If collating numbers 00 or 19 are used, see notes on Figures 18 or 20. To translate a seven-track BCD tape code character to an eight-bit byte, identify the character by collating number in Figure 19, then use this number to find the eight-bit configuration in Figure 18.

Note: When operating in even redundancy (parity) mode with translator off:

1. If the low order six bits are all zero, the BCD substitute blank (C-A—) is written;
2. If a BCD substitute blank is read, 0001 0000 is sent to the channel.

Note: Not all defined EBCDIC graphics can be written on seven-track tape via the translator.

If the translator is off in the seven-track mode, and the data converter is off or nonexistent (see "Data Conversion Feature"), data transfer takes place, as shown in Figure 21.

In a write operation, the six low-order bits in each data byte are written on tape as illustrated in Figure 21. Any bits in the two high-order positions are ignored. In a read operation, each character on tape becomes the six low-order bits in a storage data byte. Zero bits are inserted in the two high-order positions.

2415 Note: With translator on, an all-blanks record written in one parity mode and read in the opposite parity mode, does not cause a data check. The correct blank configuration for the parity mode of the read operation is sent to the channel.

Data Conversion Feature

The data conversion feature, an additional option to the seven-track feature, allows the writing and reading of *binary data* on seven-track 2400 tape units. Data conversion is set on by a control command and forces odd redundancy and translator off. Data conversion is performed as follows:

Write operation—Writing a tape with converter on causes four tape characters (24 bits) to be written for every three storage bytes (24 bits). (See Figure 22.) Reading such a tape reverses the process by converting four tape characters into three storage bytes. (Data conversion reduces the data transfer rate to 3/4 of the rate for nine-track NRZI operation.) When data written from storage is not a multiple of three bytes, the last one or two bytes are written as follows:

One byte is converted to two tape characters; bits 8, 4, 2, and 1 of the second character are written as zeros.

Data Byte 1														
0	1	2	3	4	5	6	7							
B	A	8	4	2	1	B	A	0	0	0	0			
Tape Char 1							Tape Char 2							

Two bytes are written as three tape characters; bits 2 and 1 of the third character are written as zeros.

Data Byte 1							Data Byte 2										
0	1	2	3	4	5	6	7	0	1	2	3	4	5	6	7		
B	A	8	4	2	1	B	A	8	4	2	1	B	A	8	4	0	0
Tape Char 1							Tape Char 2							Tape Char 3			

	8421	BA 11	B- 10	- A 01	-- 00
0	0000	06	12	19	00
1	0001	A 26	J 36		1 55
2	0010	B 27	K 37	S 46	2 56
3	0011	C 28	L 38	T 47	3 57
4	0100	D 29	M 39	U 48	4 58
5	0101	E 30	N 40	V 49	5 59
6	0110	F 31	O 41	W 50	6 60
7	0111	G 32	P 42	X 51	7 61
8	1000	H 33	Q 43	Y 52	8 62
9	1001	I 34	R 44	Z 53	9 63
A	1010				0 54
B	1011	.		'	# 20
C	1100			%	@ 21
D	1101				22
E	1110		;		23
F	1111				24

Figure 19. Magnetic Tape Code For BCDIC

COLLATING NUMBER*	ASSIGNED GRAPHICS	PRINCIPLE GRAPHIC NAME	ALTERNATE GRAPHIC NAME	CARD CODE**			SEVEN-TRACK MAGNETIC TAPE BCD CODE (EVEN PARITY)						
				NO PUNCHES			C	B	A	8	4	2	1
00	BLANK	Blank (Space)		NO PUNCHES			NO BITS***						
01	.	Period		12	3	8	C	B	A	8	4	2	1
02) (Lozenge	Right Parenthesis	12	4	8		B	A	8	4	2	1
03	[Left Bracket		12	5	8	C	B	A	8	4	2	1
04	<	Less-Than Sign		12	6	8	C	B	A	8	4	2	1
05	≠	Group Mark		12	7	8		B	A	8	4	2	1
06	& +	Ampersand	Plus	12				B	A	8	4	2	1
07	\$	Dollar Sign		11	3	8		B		8	4	2	1
08	*	Asterisk		11	4	8	C	B		8	4	2	1
09]	Right Bracket		11	5	8		B		8	4	2	1
10	;	Semi-Colon		11	6	8		B		8	4	2	1
11	Δ	Mode Change		11	7	8	C	B		8	4	2	1
12	-	Minus Sign, Hyphen		11			C	B					
13	/	Slash		0	1				A				1
14	,	Comma		0	3	8			A	8		2	1
15	% (Per Cent Sign	Left Parenthesis	0	4	8	C		A	8	4		
16	V	Word Separator		0	5	8			A	8	4		1
17	\	Backslash		0	6	8			A	8	4	2	1
18	#	Segment Mark		0	7	8	C		A	8	4	2	1
19 ***	b	Substitute Blank			2	8	C		A				
20	# =	Number Sign	Equal Sign		3	8	C			8		2	1
21	@ .	At Sign	Prime, Apostrophe		4	8				8	4		
22	:	Colon			5	8	C			8	4		1
23	>	Greater - Than Sign			6	8	C			8	4	2	1
24	√	Tape Mark (Radical)			7	8				8	4	2	1
25	?	Question Mark		12	0			B	A	8		2	
26	A			12	1		C	B	A				1
27	B			12	2		C	B	A			2	
28	C			12	3			B	A			2	1
29	D			12	4		C	B	A		4		
30	E			12	5			B	A		4		1
31	F			12	6			B	A		4	2	
32	G			12	7		C	B	A		4	2	1
33	H			12	8		C	B	A	8			
34	I			12	9			B	A	8			1
35	!	Exclamation Point		11	0		C	B		8		2	
36	J			11	1			B					1
37	K			11	2			B				2	
38	L			11	3		C	B				2	1
39	M			11	4			B			4		
40	N			11	5		C	B			4		1
41	O			11	6		C	B			4	2	
42	P			11	7			B			4	2	1
43	Q			11	8			B		8			
44	R			11	9		C	B		8			1
45	≠	Record Mark		0	2	8	C		A	8		2	
46	S			0	2			A				2	
47	T			0	3		C		A			2	1
48	U			0	4			A			4		
49	V			0	5		C		A		4		1
50	W			0	6		C		A		4	2	
51	X			0	7			A			4	2	1
52	Y			0	8			A	8				
53	Z			0	9		C		A	8			1
54	0				0					8		2	
55	1				1		C						1
56	2				2		C					2	
57	3				3							2	1
58	4				4		C				4		
59	5				5						4		1
60	6				6						4	2	
61	7				7		C			8	4	2	1
62	8				8		C			8			
63	9				9					8			1

BCD INTERCHANGE CODE

- * Collating Number for BCDIC and System/360 BCDIC subset of EBCDIC.
- ** Card Code for BCDIC and System/360 subset of EBCDIC
- *** A no-bit blank character cannot be written on even parity tape; the substitute blank character is composed of a CA bit combination on tape.

Figure 20. Standard BCD Interchange Code and Graphics

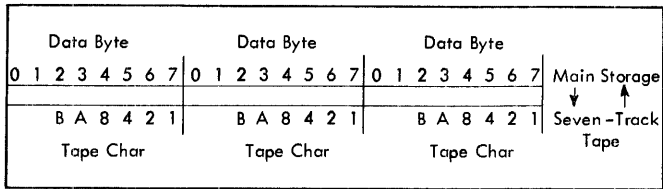

Figure 21. Data Translation – Translator Off and Converter Off

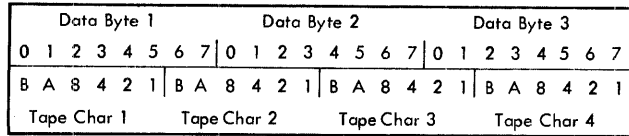

Figure 22. Data Conversion – Data Converter On

Read operation—The first 24 bits of the tape block (four tape characters) are converted to 3 eight-bit data bytes in main storage. Tape and storage bit relationships are shown in Figure 22.

Data conversion cannot be done while reading backward. A read backward command overrides data converter on.

When reading tape written in the data conversion mode, the number of characters read back is the same as the number of characters written, and data conversion check is not indicated. When data read from tape not written in the data conversion mode is not a multiple of four characters in length, the last one, two, or three characters of each block are converted as follows:

One tape character is converted to one data byte with bits 6 and 7 of the data byte set to 0. Unit check and data conversion check are set.

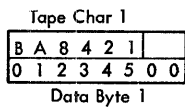

Two tape characters are converted to one data byte if bits 8, 4, 2, and 1 of the second tape character are all 0. Unit check and data converter check are not set. If bits 8, 4, 2, and 1 are not all 0, the two tape characters are converted to two data bytes with bits 4, 5, 6, and 7 of the second byte set to 0. Unit check and data converter check are set.

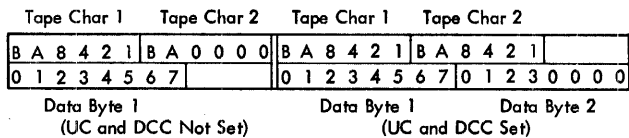

Three tape characters are converted to two bytes if bits 2 and 1 of the third character are 0. Unit check and data converter check are not set. If bits 2 and 1 are not 0, the three tape characters are converted to three data

bytes with bits 2, 3, 4, 5, 6, and 7 of the third byte set to 0. Unit check and data converter check are set.

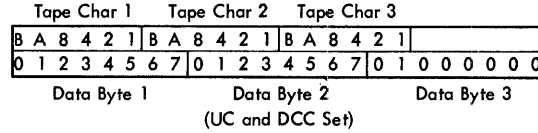
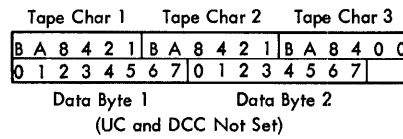

Note: If tapes are read in the data conversion mode and the tapes had been either generated externally or written in some other mode, it is possible to determine the exact content and length of the block by using a combination of byte length and data conversion check.

Determine the modulo 3 remainder byte count (remainder after division by 3) of the number of bytes transferred to main storage and the setting of the data converter sense bit (bit 7, byte 0). To determine the necessary adjustment of the data field length see Figure 23.

During read/write operations, an odd/even count is made for each group of 24 bits before and after data conversion. If the counts do not compare, unit check is set in the status byte, and C compare and data check are set in the sense byte. The data converter off and translator off operation is described under “Seven-Track Feature” (Figure 21). Overrun or stop terminates data transfer and prevents a data convert check.

Bytes Remainder	Data Converter Sense Bit	Characters From Tape	Bit Position-Last Tape Bit		Adjustment of Data Field
			Byte	Bit	
0(3)	Off	4	3	7	None
0(3)	On	3	3	1	Delete six 0 bits
1	Off	2	2	3	Add four 0 bits
1	On	1	1	5	Delete two 0 bits
2	Off	3	3	1	Add two 0 bits
2	On	2	2	3	Delete four 0 bits

Figure 23. Data Field Conversion Adjustment

Dual Density Feature

The dual density feature, available with the Models 4, 5, and 6 of the 2401-2403 tape units, allows the program to utilize the tape unit as either an 800 bpi or a 1,600 bpi machine. Either the nine-track (800 bpi NRZI) compatibility feature, or the seven- and nine-track (800 bpi

NRZI) compatibility feature is a control unit prerequisite to the dual density feature. With the dual density feature installed, the tape unit can read and write tape compatible with all models (nine-track) of 2400 tape units.

To set the desired writing density, the channel program issues a mode setting control command to the tape control unit to indicate a density setting of either 800 bpi or 1,600 bpi. (See "Mode Set Commands.") The read operation requires no mode setting command; the tape unit is set to read at the density indication on the tape at load point. A burst of bits in the P-track at load point identifies to the tape unit, tape written at 1,600 bpi. The lack of this burst of bits identifies tape written at 800 bpi (Figure 9).

Nine-Track (800 bpi NRZI) Compatibility Feature

This control unit feature allows 2401-2403 Model 4-6 tape units that have the dual density feature installed to read and write nine-track 800 bpi NRZI tapes, as well as 1,600 bpi phase-encoded tapes. This dual density capability eliminates the need for additional nine-track 800 bpi drives in installations having or desiring mixed density nine-track libraries. Operation of 800 bpi NRZI Model 1-3 tape units is also permitted provided the tape units have the mode compatibility feature installed.

Mode Compatibility Feature

This tape unit feature enables NRZI tape units (Models 1, 2, and 3) to operate with PE tape controls (2803/2804 Model 2 or 2403 Models 4, 5, or 6)

Seven- and Nine-Track (800 bpi NRZI) Compatibility Feature

This feature (Figure 24) permits the tape control unit to read and write seven-track tapes at 200, 556, and 800 bpi, as well as nine-track tapes at 800 or 1,600 bpi.

2415 Compatibility Features

Three of the foregoing features are available for 2415 tape units.

1. The seven-track compatibility feature is required for the 2415 Models 1-6 control if at least one attached drive is equipped with a seven-track read/write head.
2. The nine-track compatibility feature may be installed in the 2415 Models 4-6 control to allow attached nine-track drives to read and write tape at either 800 or 1,600 bpi.
3. The seven- and nine-track compatibility feature may be installed in the 2415 Models 4-6 control to enable seven-track drive operation (at 200, 556, or 800 bpi), as well as nine-track drive operation at either 800 or 1,600 bpi.

STATUS INFORMATION AND SENSE DATA

Status Information

Status information consists of the channel status byte (eight bits of information that indicate the status of the channel) and the unit status byte (eight bits of information that indicate the status of the selected control unit and tape unit). Status information is present in the tape control or channel until the channel status word (CSW) is stored or another operation is accepted. Status information is renewed at the beginning of each tape operation (except test I/O) to indicate initial status; it is updated during the tape operation to provide ending status at termination of the I/O operation. This information is set in the status portion, bits 32-47, of the channel status word by an I/O interruption. Under certain conditions, the status information may be set in the CSW by a 'start I/O', 'test I/O', or 'halt I/O' instruction. Bits 32-39 of the CSW (unit status byte) identify to the program the conditions in the tape control that caused the storing of the CSW. Bits 40-47 of the CSW indicate conditions associated with the channel and are described in the publication *IBM System/360 Principles of Operation*, Form A22-6821.

The following unit status conditions are detected by the tape control unit (TCU) and are indicated to the channel:

Bit	Designation
32	Attention
33	Status modifier
34	Control unit end
35	Busy
36	Channel end
37	Device end
38	Unit check
39	Unit exception

Unit Status Byte

Bit 0—Attention

Not used.

Bit 1—Status modifier

Present with busy to indicate TCU busy, or has interrupt pending.

Bit 2—Control unit end

Signaled by the TCU:

1. At completion of an operation during which a TCU busy was indicated
2. At the completion of the control unit portion of an operation during which a unit check or unit exception is detected.
3. At completion of a command on the alternate interface of a simultaneous read/write TCU that caused the TCU busy to be given. (2415—not applicable.)

Bit 3—Busy

The busy status indication can change at any time. When presented without bit 1 (status modifier), indicates:

1. That the addressed tape unit is busy (i.e., rewinding),
2. The addressed tape unit is switched.

When presented with bit 1, indicates:

1. That the TCU has an interrupt pending, or
2. For the simultaneous TCU, the addressed tape unit is in operation on the alternate interface, or
3. The interface section required by the command is already in operation with a similar type command.

Bit 4—Channel end

Indicates that a read, read backward, write, control, or sense command has been completed, or in the case of certain control commands involving tape motion, that the operation has been initiated at the TCU, and the channel has been released.

Bit 5—Device end

Indicates:

1. The tape unit has completed a command, or
2. The tape unit has changed from not ready to ready, if an attempt had been made to select it while it was not ready, e.g., by issuing a 'test I/O' instruction; or the tape control initiated a rewind-unload that caused the tape unit to go not ready, or
3. A tape unit has reached load point as the result of a program-initiated rewind, or
4. A rewind-unload is completed at the control unit level, i.e., when the tape unit becomes not-ready, or
5. A switched tape unit has become not switched, if an attempt had been made to select it while it was switched (excepting the 2415).

Bit 6—Unit check

Set whenever:

1. Any bit in sense byte 0, or bit 7 of byte 1, is set to 1.
2. The tape unit performs read backward, backspace block, or backspace file into or at load point.
3. A rewind-unload is completed at the TCU level.

Bit 7—Unit exception

Set when:

1. A write, write tape mark, or erase gap operation is performed in the end of tape area, i.e., when tape indicate is on, or
2. A tape mark is sensed during a read, read backward, forward space block, or backspace block.

Programming Notes: Tape indicate (TI), set on by sensing the EOT reflective marker in the forward direction, stays on until set off (See Figure 15). Unit exception, however, remains set in unit status only until the channel accepts status, except for a sense, NOP, or test I/O operation.

If a tape mark is read in a density other than the density in which it was written, proper recognition is not guaranteed.

Sense Data

Sense data provides detailed information about the selected I/O device and the last I/O operation on the TCU. The information consists of both unusual conditions detected in the last operation and the status of the device. The status information provided by the sense command is more detailed than that supplied by the unit status byte and may describe reasons for the unit check indication.

Sense Operation

The sense operation causes the transfer of the sense data from the selected tape unit and from the tape control unit to main storage. The data is placed in storage in an ascending order of addresses, starting with the address specified in the CCW. The number of bytes to be transferred is specified by the count field in the CCW; a maximum of six can be transferred.

Programming Note: Any sense information bits (except bits 1-6 of byte 1) pertaining to the last I/O operation are reset by the next command, other than a sense command, 'test I/O' instruction, or NOP command addressed to the control unit. If the control unit detects an equipment error or invalid parity of the sense command code, the equipment check or bus-out check bits are turned on, and unit check is sent, with the channel end. In the case of invalid parity of a command, sense data that pertains to the preceding operation is not reset.

The following information describes the significance of the sense data for 2400 tape units.

Sense Byte 0

BIT	DESIGNATION	2401-2404, 2415 and 2420 INTERPRETATION	
		MODELS 1-3 (AND MODELS 4-6, 800 BPI, NRZI MODE)	MODELS 4-6 and Model 7 (1,600 BPI, PE)
0	Command reject	Set when a write, write tape mark, or erase command is addressed to a file protected tape unit, or a data-converter-on control command that is addressed to a <i>seven-track tape unit</i> is recognized on a TCU with the seven-track compatibility feature but without the data converter feature. In this case, mode set is executed for parity, density, and translator.	Same as Models 1-3
1	Intervention required	Present whenever tape unit status A is inactive, i.e., tape unit is not ready or nonexistent. See "Sense Byte 1." Channel and device end, and unit check in the unit status byte and <i>intervention required</i> in the sense data are indicated if a tape unit becomes not ready while performing a command. See also Bit 3, Byte 0.	Same
2	Bus-out check	Set whenever even parity appears on the information bus lines from the channel to the control unit.	Same
3	Equipment check (excluding 2415) Equipment check (2415)	Set when reject tape unit (bit 1, byte 4) or sequence error (bit 5, 6, or 7 of byte 4) is set. Set when an internal error occurs when counting delays.	Set when reject tape unit (bit 1, byte 4) is set Same
4	Data check	Set when a data check occurs. See "Sense Byte 3." See also Byte 1, bit 0 during a write operation.	Same, see also "Sense Byte 4."
5	Overrun	Set if service is requested, but data cannot be transferred during a read, write, or read backward operation. Data transfer stops as soon as condition is detected. <i>Note:</i> Data check during overrun suppresses the overrun indication except for 2415 where overrun suppresses all data checks except LRC.	Same
6	Word count zero	Set during a write operation if transfer of data is prevented before the first byte of data. When word count zero is set, no tape motion occurs.	Same
7	Data converter check	See "Data Conversion Feature."	Same

Sense Byte 1

BIT	DESIGNATION	2401-2404, 2415 and 2420 INTERPRETATION																						
		MODELS 1-3 (AND MODELS 4-6, 800 BPI, NRZI MODE)		MODELS 4-6 and MODEL 7 (1,600 BPI, PE)																				
0	Noise (exclucing 2415)	<p>During a read or forward space block, indicates that data was recognized after the normal LRC byte time but not long enough after to be considered a new block. Data before the LRC byte is checked and transferred; data after the LRC byte turns on the noise bit and maintains tape motion, but is not transferred.</p> <p>When connected to Model 2 control, during a read backward or backspace block, if data is recognized after the disconnect sequence is started. With Model 1 control, data recognized after start of disconnect, is transferred as part of block. Noise bit is not set; data check is probable.</p> <p>During a write, erase gap, or write tape mark, indicates that data (or noise caused by tape defects) was detected at the read head before the block or tape mark was written, or during erase gap while the tape was being erased. Data check and unit check are indicated.</p>		<p>Set during read of read backward if a data check occurs.</p>																				
0	Noise (2415)	<p>During a write or write tape mark, indicates that data (or noise caused by tape defects) was detected at the read head before the block or tape mark was written.</p>		<p>Same</p> <p>Set during read or read backward if a data check occurs.</p>																				
1*	TU status A	Selected and ready		Same																				
2*	TU status B	Not ready, or rewinding, or under the control of another TC via the 2816 Switching Unit. Assuming no outstanding device end status, the bits determine response to initial selection as follows:		Same																				
		<table border="1"> <thead> <tr> <th>Tape Unit Status A</th> <th>Tape Unit Status B</th> <th>Tape Unit Status</th> <th>Response to Initial Selections</th> </tr> </thead> <tbody> <tr> <td>0</td> <td>0</td> <td>Nonexistent</td> <td>Unit check</td> </tr> <tr> <td>0</td> <td>1</td> <td>Not ready</td> <td>Unit check, arm for device end</td> </tr> <tr> <td>1</td> <td>0</td> <td>Ready and not rewinding and not switched*</td> <td>Clear status</td> </tr> <tr> <td>1</td> <td>1</td> <td>Ready and rewinding or switched* or power is down on a tape unit attached through a switching unit.</td> <td>Busy, arm for device end</td> </tr> </tbody> </table>	Tape Unit Status A	Tape Unit Status B	Tape Unit Status	Response to Initial Selections	0	0	Nonexistent	Unit check	0	1	Not ready	Unit check, arm for device end	1	0	Ready and not rewinding and not switched*	Clear status	1	1	Ready and rewinding or switched* or power is down on a tape unit attached through a switching unit.	Busy, arm for device end		
Tape Unit Status A	Tape Unit Status B	Tape Unit Status	Response to Initial Selections																					
0	0	Nonexistent	Unit check																					
0	1	Not ready	Unit check, arm for device end																					
1	0	Ready and not rewinding and not switched*	Clear status																					
1	1	Ready and rewinding or switched* or power is down on a tape unit attached through a switching unit.	Busy, arm for device end																					
	(2415)	<p><i>Note:</i> Unit check is not signaled for a sense operation. Following unit check or busy indication, device end will be signaled when the tape unit becomes ready and not rewinding.</p> <p>No references to the 2816 Switching Unit apply.</p>																						
3	Seven-track	The selected tape unit has the seven-track feature installed.		Same for 2415 Always 0 for 2401-2403 and 2420																				
4	Load point	The selected tape unit is at load point. Data received while reading backward into load point is not to be considered valid even if there is no data check.		Same																				
5	Selected and write status	The selected tape unit is in write status.		Same																				
6	File protect (no write enable ring).	The selected tape unit is in file protect status.		Same																				
7	Not capable	Not used, always set to zero.		Density (800/1600 bpi) handling features of tape unit and/or control are not compatible with the mounted tape. (Indicated after read from LP.) Unit check is set in the status byte.																				

*Switched means that the tape unit is selected by some other control unit under control of a tape unit switch.

Sense Byte 2

2401-2404, 2415 and 2420 INTERPRETATION	
MODELS 1-3 (AND MODELS 4-6, 800 BPI, NRZI MODE)	MODELS 4-6 and MODEL 7 (1,600 BPI, PE)
This sense byte contains the track-in-error indicator bits that are set at the end of a read or read backward command if a data check has been encountered. See "Cyclic Redundancy Check." At the end of a properly executed read or read backward with no data check, sense byte 2 contains at least bits 6 and 7 set to ones. No error correction is attempted when operating with seven-track tape units; bits 6 and 7 are set to ones in sense byte 2.	Not Applicable. Contains maintenance aid bits
2415: Not applicable; bits 6 and 7 set to 1 unconditionally.	

Sense Byte 3

BIT	DESIGNATION	2401-2404, 2415 and 2420 INTERPRETATION	
		MODELS 1-3 (AND MODELS 4-6, 800 BPI, NRZI MODE)	MODELS 4-6 and MODEL 7 (1,600 BPI, PE)
0	R/W VRC (2401-4 Models 1-6) Data reg VRC (2415 Models 1-6)	A vertical redundancy check occurred during a read or read backward operation. This bit is not set after an overrun or after receipt of a stop signal (CCW count less than block length) or a halt I/O.	A vertical redundancy check (VRC) occurred during read or read backward operation that could not be corrected (CCW count less than block length) or halt I/O. A VRC occurred during checking of a write on a 2420.
1	LRCR (Models 1-3) Multiple Track Error (Models 4-6)	A longitudinal redundancy check occurred during write, write tape mark, read, or read backward operation.	Weak signal in more than one track on a read or read backward operation. Data is incorrect. During a write command, excessive velocity variation was detected.
2	Skew	Excessive skew detected by a read back check during a write, write tape mark, or erase operation.	Excessive skew detected during a read or read backward operation.
3	CRC (Models 1-3) End data check (Models 4-6)	A cyclic redundancy check occurred during a read or read backward operation (nine-track only). 2415: Not Applicable.	Set when sync burst following data block, not properly recognized, or improperly recognized before actual end of data. 2415: Set with false end of block indication.
4	Skew reg VRC (Models 1-3) Envelope check (Models 4-6)	A character with incorrect parity detected in skew register during write, write tape mark, or erase operation.	Indicates at least one track with low signal while writing. Set if a write trigger VRC occurred.
4 (2415)	Read reg VRC (Models 1-3) Envelope check (Models 4-6)	A character with incorrect parity detected in read register during write or write tape mark operation.	Indicates at least one track with low signal while writing.
5	Phase encoding	Not applicable; always set to zero.	Selected tape unit is set to PE recording mode.
6	Backward	The selected tape unit is in backward status.	Same
7	C compare	Indicates that parity of data into the data register did not equal that out of the data register.	Same

Note: Bits 0-4 and 7 of byte 3 indicate data checks. Any of these will set data check (bit 4, byte 0).

Sense Byte 4

BIT	DESIGNATION	2401-2404 and 2420 INTERPRETATION	
		MODELS 1-3 (AND MODELS 4-6, 800 BPI, NRZI MODE)	MODELS 4-6 and MODEL 7 (1,600 BPI, PE)
0	Echo Check	Write trigger malfunctioned. Equipment check (bit 3, byte 0) is also set.	Not used
1	Reject TU	Selected tape unit failed to respond to set read or set write status when instructed, or became not ready during execution of a tape motion operation. Equipment check (bit 3, byte 0) also set.	Same
2 3	Read clock Write clock/write trigger VRC	Maintenance aids	Not used Maintenance aid. Write trigger malfunctioned in either PE or NRZI. Sets envelope check (bit 4, byte 3).
4	Delay counter/ start read check		Set when a PE read (forward or backward) command has a track with low amplitude in the preamble (postamble) such that the read operation does not start properly. Data check, noise bit and unit check are also set.
5 6	C sequence B sequence	Maintenance aid. Sets equipment check.	Set in event of a machine failure and cause a data check and unit check.
7	A sequence	Maintenance aid. Sets equipment check	Maintenance aid. Sets data check

Sense Byte 5

BIT	DESIGNATION	2401-2404 and 2420 INTERPRETATION	
		MODELS 1-3 (AND MODELS 4-6, 800 BPI, NRZI MODE)	MODELS 4-6 (1,600 BPI, PE)
0	Reserved for future use	Always zero	Always zero
1	Reserved for CE function		
2-5	None	Always zero.	Always zero
6	Diagnostic mode	A control with a special diagnostic function is in the diagnostic mode.	
7	Reserved for RPQ use	Always zero	Always zero

Note: Bytes 4 and 5 are always zero for the 2415.

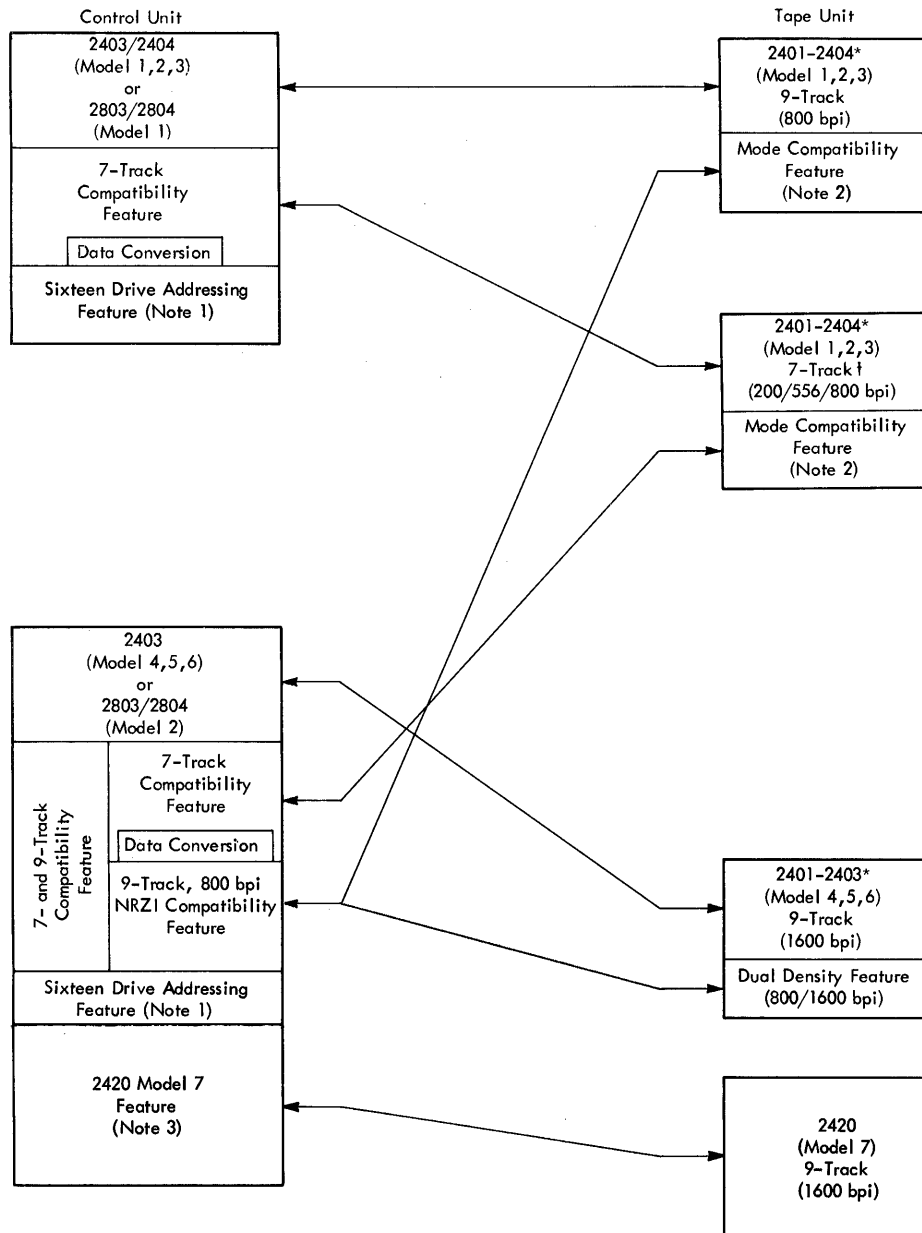

* 2401 and 2402 Models 1, 2, 3 tape drives require the Simultaneous Read-while-Write feature when attached to a 2404 or 2804 Model 1 control unit. The same applies to Model 4, 5, 6 drives with the 2804 Model 2.

† The 7-track read/write head cannot be installed on 2401-2403 Models 4-6 tape units.

NOTES:

1. The sixteen drive addressing feature allows the control unit to address up to 16 tape units through two 2816 Switching Units. The 2816 Model 1 Switching Unit can switch up to sixteen 2401-2403 tape units in any combination of models by installing the Tape Drive Intermix feature. However, the 2816 Model 1 cannot switch both Model 1 (800 bpi) and Model 2 (1600 bpi) control units in the same system configuration.
2. The mode compatibility feature is required on 2401-2404 Models 1, 2, 3 tape units to allow them to operate with a Model 2 control unit.
3. The 2420 Feature is available only on 2803 Model 2 tape controls with serial numbers between 14000 and 30000.

Figure 24. 2401-2404 Special Features Configurator

2404/2804 Simultaneous Tape Control

The simultaneous read-while-write control units (Figure 25) contain:

1. Two I/O interface sections, each equivalent to the I/O interface section of a 2403/2803 control unit. The interface section contained in the 2403/2803 control unit transfers all data and control signals between the tape drive and control unit for all tape operations.
2. Two tape adapter sections: one (the write section) performs write-type operations (write, write tape mark, and erase gap); the other (the read section) performs read-type operations (read, read backward, rewind, rewind-unload, forward space block, forward space file, backspace block, and backspace file). The NOP, sense, and mode-setting commands are executed by the I/O interface section and do not use either the read or write adapter section.

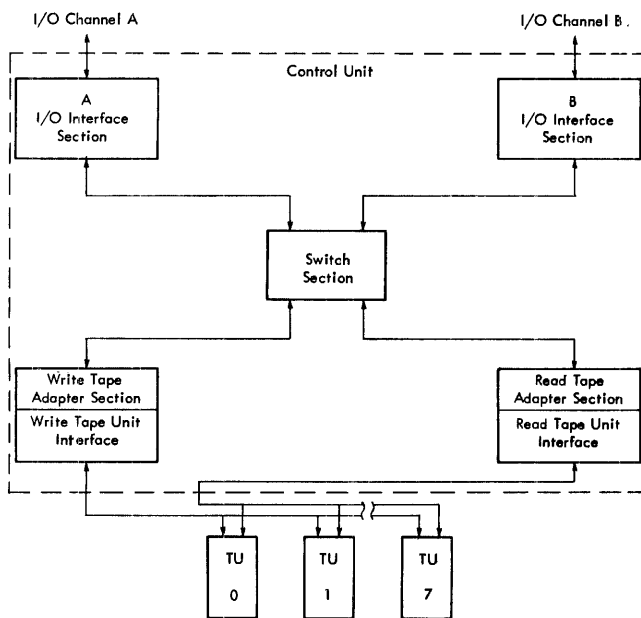

Figure 25. Simultaneous Read-While-Write Control Unit

The seven- or nine-track mode set in an I/O interface section applies to all corresponding operations initiated by the associated channel. The alternate channel must likewise set mode for its tape operations on the alternate interface. Neither mode set affects the other. The modes remain set in their respective sections until changed or reset.

3. Two tape unit interfaces: one between the tape units and the read section, the other between the tape units and the write section.
4. One switch section used (a) to logically connect either tape adapter section to either I/O interface section and (b) to generate control unit busy responses when necessary to prevent interference between the two I/O interface sections.

Operation of the 2404/2804 is identical to operation of the 2403/2803 with the exception of responses generated by the switch section. These responses are:

1. Control unit busy (CUB) is generated whenever one I/O interface section attempts to use a tape adapter section that is presently operating with the alternate I/O interface section* (command interference); or whenever an operating tape unit is addressed by the alternate I/O interface (address interference).
2. Control unit end (CUE) is generated when the alternate I/O interface section becomes idle and not command chaining, after receiving a control unit busy signal. The CUE generated in this case may be presented with any address (0-7) that the I/O interface section is capable of recognizing, including tape units not actually connected.

An operation can be performed between a CUB and its resulting CUE if the CUB is caused by command or address interference with the alternate interface (see item 1). End status for the intervening operation will be presented to the channel before the CUE (noted in item 1). This type of CUE (stated in item 1) presented by itself can be cleared (status byte sent to channel) by a 'test I/O' or 'start I/O,' with any valid address. In the case of a 'start I/O,' busy is also presented and no tape operation results.

The 2404 and 2804 control units cannot be used with the 2816 Switching Unit.

All 2401-2403 tape units to be used with a 2404/2804 simultaneous control must be modified to permit simultaneous read-while-write operations.

*When start I/O specifies a mode-setting NOP or sense command, command chaining is on, and condition code zero results, the subsequent read- or write-type command may find the desired (read/write) tape adapter section busy executing an operation with the alternate I/O interface. The same situation can result if write-type and read-type commands are intermixed in a command chain (e. g., backspace, erase gap, and write).

Busy under these conditions terminates chaining and generates an interruption condition that is left pending in the subchannel. Busy and status modifier are stored in the unit status byte of the CSW. This interruption can be cleared (a full CSW stored) by allowing a normal I/O interruption or by test I/O.

A simultaneous control is not available for the 2415 or 2420 tape units.

Note: Command interference circuits still operate when either the A or B interface is placed off-line at the CE panel, and operations performed on the off-line interface can affect the on-line interface. An off-line (CE panel) operation selects the read or write control section plus a tape unit, which prevents the on-line interface from selecting that control section or tape unit. The off-line interface has access to the same group of tape units being used by the on-line interface, and CE panel operations can alter or destroy information being processed by on-line operations. Therefore, extreme caution should be exercised when using one interface off-line with the other interface on-line.

SIMULTANEOUS CONTROL PROGRAMMING AIDS

When control unit end (CUE) appears in status, it means the control unit is available for another operation. That is, the control unit is free to access a device. The device address associated with a CUE may be any of the addresses assigned to the control unit if CUE appears alone in the status. When a control unit becomes free, only one CUE is presented to the CPU, although the control unit may have responded with busy status to the CPU more than once. In the following examples, one of the two I/O interface sections of a simultaneous tape control unit (TCU) is connected to channel 1 and the other to channel 2.

Example 1: Channel 1 executes a write operation, then channel 2 attempts a write operation; channel 2 is signaled a control unit busy as initial status. This results in arming channel 2 interface circuitry to produce an interrupt with CUE in unit status on termination of the write operation on channel 1. Note that this control unit end does not accompany the channel end (CHE) and device end (DVE) status stored by channel 1 in ending status. The control unit end is presented during a separate interrupt via channel 2.

If, following the CUB, the program loops on the write command to channel 2, it is possible for the write command on channel 2 to be completed before the CUE (due to the CUB) is presented. The same is true for read-type commands.

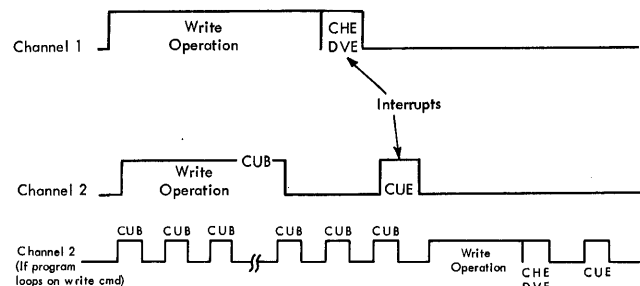

Example 2: In the preceding example, channel 2 could have issued a read operation after finding the write interface busy. In this case, the read operation is initiated, but the CUE status is not stored until CHE and DVE have been stored at the conclusion of both operations.

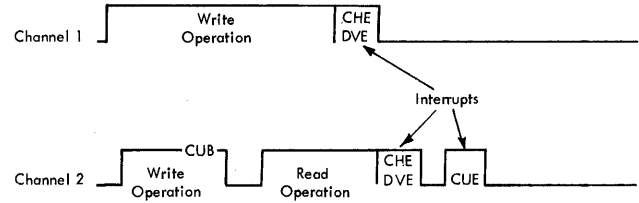

Example 3: A further complication of the preceding examples could occur in a multiprogramming environment. If channel 1 executes a write operation and subsequently channel 2 attempts a write operation, channel 2 will encounter the control unit busy condition. Channel 2 then proceeds to execute a read operation. While channel 2 is performing the read operation, channel 1 completes its write operation and attempts a read operation. The read operation encounters the control unit busy condition, and channel 1 attempts no further operations. When channel 2 completes its read operation, channel end and device end are signaled normally with an interrupt. Following this, two more interrupts will be signaled—one from channel 1, containing control unit end and one from channel 2, containing control unit end.

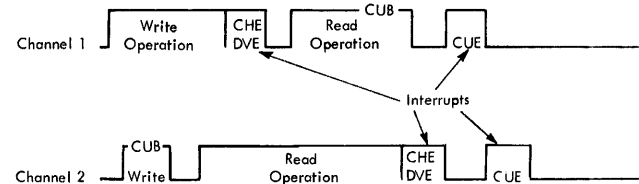

Example 4: Assume that I/O interrupts are masked off for channels 1 and 2. Assume further that start I/O initiates the following chained operations on channel 1: mode set and write. Condition code zero is set. While channel 1 is executing its write operation, start I/O initiates the following chained operations on channel 2: mode set, backspace block and erase gap. Condition code zero is set. The channel 2 chained operation progresses normally to the erase gap command, and then is rejected with CU busy. In addition, because the system is masked, the CU busy interrupted will be stacked. Assume also that channel 1 completes its write operation before the system is unmasked.

When interrupts are subsequently unmasked, the following separate interrupts occur:

1. Normal ending status with channel end and device end stored in CSW by channel 1.

2. Channel 2 stores the control unit busy status (busy plus status modifier).
3. A second channel 2 interrupt stores the CUE status.

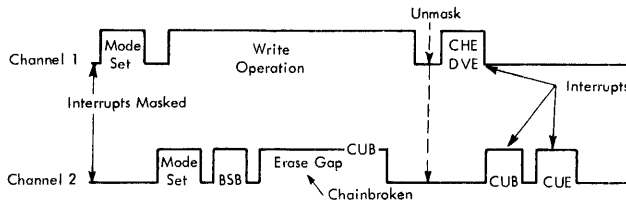

Example 5: Assume that I/O interrupts are masked off for channels 1 and 2. Channel 1 executes an erase gap operation, and a unit check occurs. Any abnormal condition, such as unit check (UC) or a control unit being addressed, which occurs during a tape operation, causes CUE to be presented with DVE in the ending status. In the case of unit check, UC is also indicated in the ending status. With interrupts masked, however, ending status is stacked in the control unit until interrupts are unmasked.

Channel 2 attempts successive write operations that encounter the control unit busy condition. A write operation on channel 2 is not accepted until the stacked condition is released on channel 1 by unmasking interrupts.

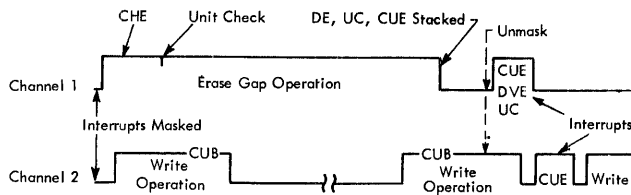

Example 6: This situation is similar to Example 5. Channel 1 is given a read operation. A data check (DC) occurs and a found track (nine-track NRZI, CRC correction only) is computed. The found track condition locks the read TCU to the channel 1 interface until a sense operation, or another read operation is given; therefore, the read operation on channel 2 cannot be accepted until this found track contingent connection is broken. The contingent connection prevents another channel from accessing the read TCU and destroying the TIE information being held by the read TCU.

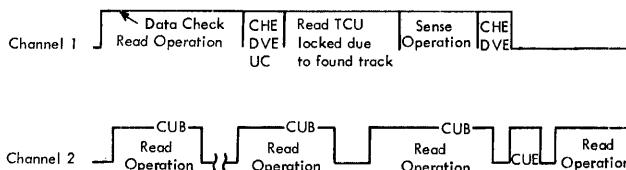

Example 7: Channel 1 is executing a read operation. Channel 2 executes a write with errors, causing the program to branch to a subroutine to perform a mode set, chained to a backspace block, chained to erase gap. Initial selection for mode set indicates TCU is available. The program proceeds, assuming that channel 2 is performing normally. An interrupt comes from channel 2 indicating control unit busy. The backspace block (and erase gap) was not executed because BSB is a read operation. If the program does not properly handle this status to provide a retry of the subroutine, and proceeds to do a rewrite, it is writing a duplicate record. The first record in error was not erased.

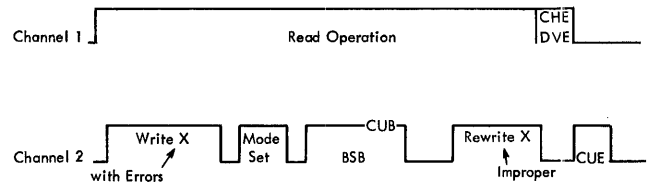

Example 8: Channel 1 is alternating between read and write operations. Channel 2 writes with errors, and the program branches to a subroutine that chains a mode set to a backspace block, to an erase gap. The erase gap operation is attempted when the write TCU is busy and CUB is presented. If the program assumes that the operation failed and repeats the entire chained operation, the second backspace block will take place over a previously written good block; that good block will subsequently be erased.

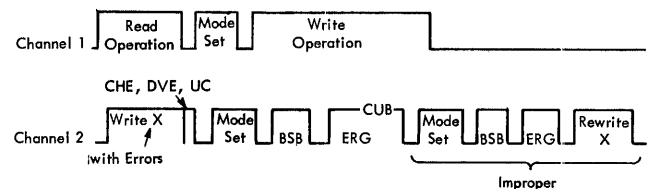

Some programs used the following sequence when operating a tape unit:

- LA GR6, WRTCCW (Load address of write CCW into general register 6)
- ST GR6, CAW (Store general register 6 in the CAW)
- TIO 0(GR7) ("Test I/O" for device whose address is in general register 7)
- BC NOT AVAILABLE, (Branch back to test I/O if device is not available) *4
- SIO 0(GR7) (If device available, 'start I/O' for device whose address is in general register 7)
- BC 15, WAITINTR (Branch to wait-for-interrupt routine)

On a non-simultaneous TCU (2403/2803), this routine works fine. A 'test I/O' is looped until the addressed tape unit becomes available, then the SIO is issued to the same drive.

On a simultaneous control, assume that a write operation is in progress on channel 1, tape unit 2. The above routine attempts a write operation via channel 2, tape unit 3. The TIO to channel 2, tape unit 3, yields an "available" status indication because the simultaneous TCU can use either the write TCU or read TCU to perform a TIO. Because test I/O resulted in an "available" status indication to the program, it proceeds with the

SIO, ignores initial status, and unknowingly receives control unit busy in initial status because of write command interference. Subsequently, the program is awaiting an interrupt that contains channel end and device end; but an interrupt occurs with control unit end status only, accompanied by any arbitrary device address assigned to the control unit.

Initial status for each operation should always be tested to insure cognizance of each operation's true status. This is recommended procedure whether the tape control is a simultaneous or a non-simultaneous model.

IBM 2816 Switching Unit Model 1

The IBM 2816 Switching Unit, Model 1 (Figure 26), enables any one of several 2803 or 2403 tape controls to select any 2401, 2402, 2403, or 2420 Magnetic Tape Unit from an array or pool of tape units.

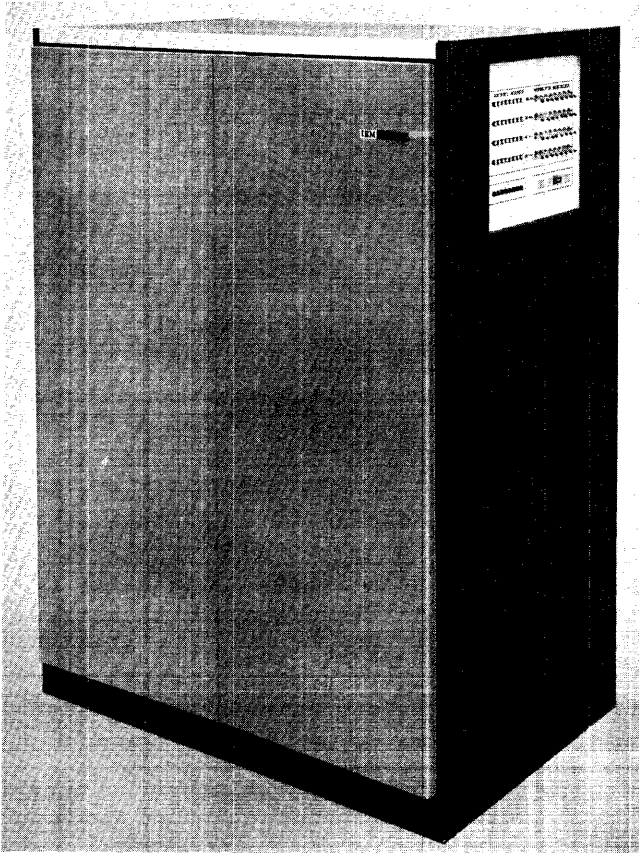

Figure 26. IBM 2816 Switching Unit Model 1

The switching is done under computer control and can be done on a per block basis. The 2816 reduces the number of tape units necessary for any given application by providing each tape unit with an increased number of access paths.

The IBM 2816 Switching Unit Model 1 is modular in design to allow flexibility for a variety of system configurations. The basic 2816 provides a two-by-four switching matrix for switching four 2401-2404 magnetic tape units (all models) between two IBM 2403 or 2803 Tape

Control Units (Figure 27). (For proper combinations of tape drives and control, see Figure 24.) With the use of available special features, the switching unit can be expanded to a maximum capability of a single 2816 that provides a four-by-eight matrix for switching eight tape units between any of four tape control units (Figure 27). The switching unit permits simultaneous operation of as many tape units as there are tape control units present in the switching configuration. Tape control units may be connected to different channels of the same system or between channels of a multisystem.

A second switching unit can be coupled to the initial unit (by adding proper features to both units) to expand the switching capability to sixteen tape units and four tape control units. (See Figure 27.) The use of two 2816's to switch more than eight tape units requires the installation of the sixteen-drive addressing feature on the tape control units. (See Note 1 of Figure 24.)

FUNCTIONAL OPERATION

The IBM 2816 Switching Unit is a passive device controlled only by the select lines of the tape control units. No additional program selection or other commands are required to use this device. Although there are necessary switching delays, data transfer, control line requests and responses, and status indication (end and error), operations take place between the tape units and the tape control units as if the 2816 were not present. Because the maximum time required to establish the data path is one millisecond, data line switching can take place within the normal tape unit start-stop time. The control and data paths are connected as long as the select signal is maintained; therefore, the one millisecond delay does not apply to chained commands.

There are no priorities assigned to the data paths between the tape units and tape control units. The connection established depends entirely on circuit speeds. If two or more tape control units simultaneously attempt to select the same tape unit, one tape control unit will select the tape unit and the other tape control unit(s) will get a "busy" indication.

Any attempt to select a tape unit via a tape control unit switched to another TCU will result in a "busy" indication. Exception: If multiple control units simultaneously attempt to select a nonexistent tape unit, one tape control will indicate "nonexistent," and the other will indicate "not ready."

OPERATOR PANEL

The operator panel (Figure 28) contains switches, lights, and indicators. The switches control tape unit on-line operation; the lights and indicators monitor the power, temperature conditions within the unit, and the specific data paths between tape control unit and tape unit.

Switches

Tape Unit Selection: There are 32 tape unit selection switches located in the upper right section of the operator panel. The switches allow the operator to restrict each tape unit to a designated channel or channels. Setting the switch to the OFF position places the associated tape unit "off-line," or physically out of the system to the associated TCU. Setting the switch to the ON position places the tape unit in an "on-line" status.

Note: Setting a tape unit selection switch off causes the tape unit to appear nonexistent to the associated tape control; therefore, once the switches are initially set, they should not be set off during the execution of any specified program in a single processor environment.

Lights

Ac On: When lit, this light indicates that primary ac power is applied to the 2816.

DC On: When lit, this light indicates that internal dc power is applied to the 2816.

Note: During the power-up or power-down sequence of the 2816, all attached tape units should be in a not-ready condition, and no attached control unit should be operating.

When a switch system is operating and it becomes necessary to drop or raise power in a control unit, all tape units should first be switched off-line to that control unit. Do not drop ac power in a control unit operating with a 2816 switching unit if attached tape units are still needed by the system or systems.

While dc power is down in a tape unit, the tape unit should be switched off-line to all control units; this prevents erroneous tape unit responses.

Thermal: When lit, this light indicates the internal machine temperature has exceeded the operating limits. Actuation of an over-temperature device causes power to drop and lights this indicator.

Indicators

Tape Unit Selection Indicators: There are 32 tape unit selection indicators located on the upper left side of the operator panel. Each indicator corresponds to an associated tape unit selection switch for a particular tape unit and tape control unit. These indicate the specific data paths used within the 2816 (the indicator is lit only when the data path is in use).

Fuse Indicators: There are six fuse indicators and two spares located at the lower left side of the operator panel. When lit, these indicate that the associated fuse for a large board within the 2816 has blown.

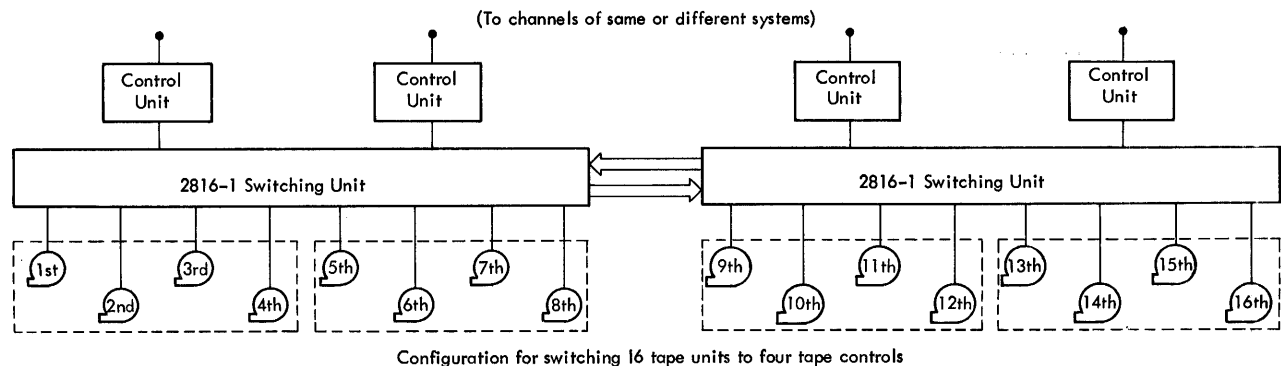
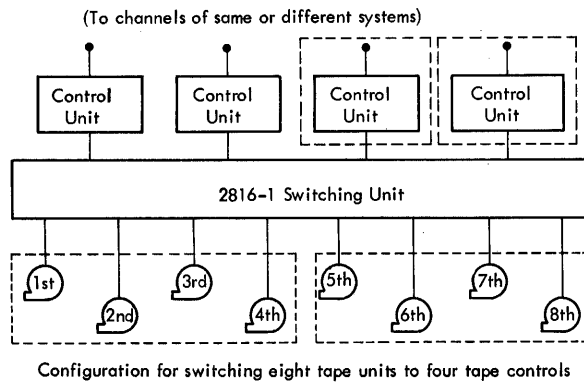

Figure 27. 2816 Switching Unit Model 1 Configurations

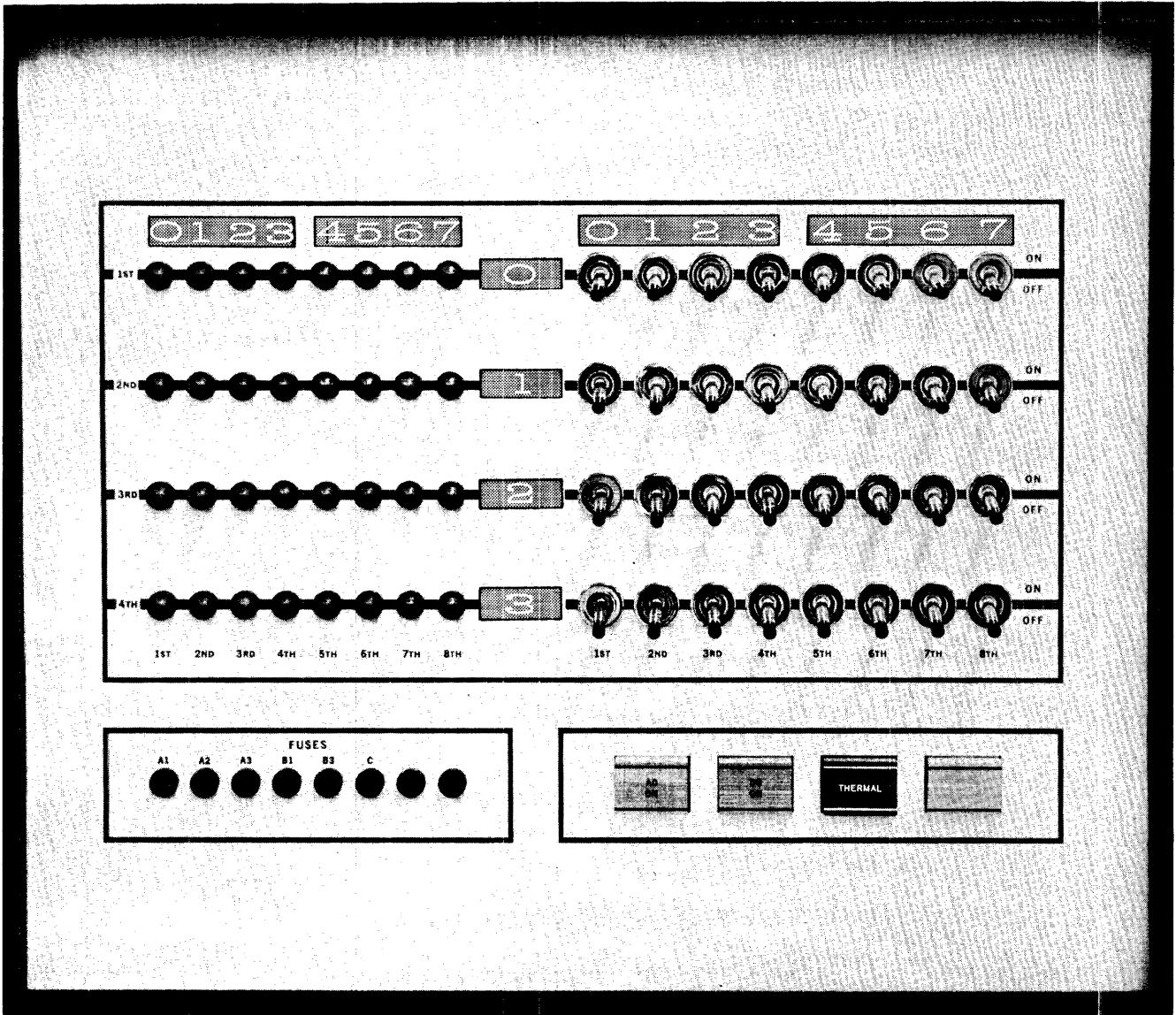

Figure 28. 2816 Operator Panel

This section describes operator controls for 2400-Series tape units. *Note:* Once an operation has begun, allow the TU to complete the operation before starting another manually-initiated operation. Also, opening the door while the TU is in motion (i.e. load, unload, rewind, etc.) is not recommended and could cause tape damage or TU hang-up.

OPERATOR KEYS—2401-2404 ALL MODELS

Figure 29 shows the 2401-2404 operator panel.

Load-Rewind: Pressing this key initiates a tape load or a rewind operation. The load-rewind key is operative only when the reel door is closed and the ready light is off. Use of this key after tape is properly mounted in the magnetic tape unit lowers tape into the columns, lowers the head assembly, and moves tape in the rewind direction until the load point reflective marker is sensed. The purpose of this key is to set the tape into the machine at the starting point (load point), ready for either reading or writing.

Use of the load-rewind key with tape loaded and the machine reel containing more than 1/2 inch of wound tape initiates a high-speed rewind operation. The amount of tape to be rewound is measured automatically by a light-beam and photocell mechanism in the tape unit. Tape is removed from the columns, the head assembly is raised, and tape is rewound at high speed until less than 1/8 inch of wound tape remains on the machine reel.

Tape is then lowered into the columns, the head assembly is lowered, and a low-speed rewind continues until the load point marker is sensed.

Use of the load-rewind key with tape loaded and the machine reel containing less than 1/2 inch of wound tape initiates a low-speed rewind until the load point marker is sensed.

CAUTION

Do not open the reel door during the rewind or load point searching. This could cause breaking or damaging of the magnetic tape.

Start: This key places the tape unit in ready status and turns on the ready light if:

1. Reel door is closed.
2. Tape is loaded into the columns.
3. Tape unit is not in the process of rewinding.

Pressing the start key disables all manual controls.

Unload: This key initiates a tape unload operation. The unload key is operative only when:

1. Ready light is off.
2. Tape is in columns.
3. Reel door is closed.

Use of this key raises the head assembly and removes tape from the columns, regardless of the distribution of the tape on the two reels. If the tape is not at load point when the operator wishes to change tape reels, a load point search should be initiated first by pressing the load-rewind key. Pressing the unload key also turns off the tape indicate light, if on.

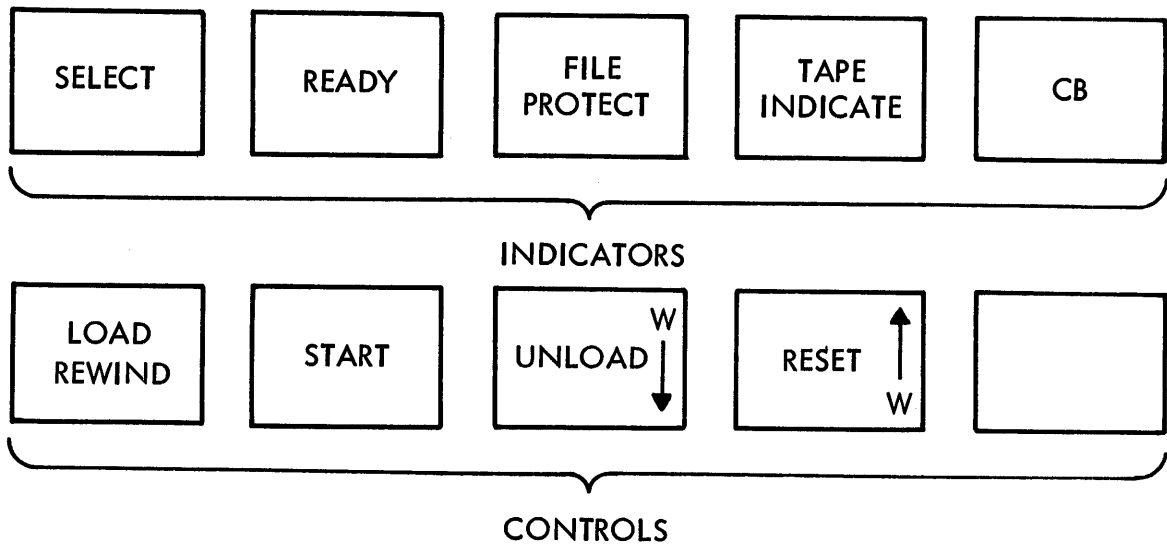

Figure 29. 2401-2404 Operator Panel

Reset: This key resets the tape unit from ready status. In this condition, no operations can be performed through the tape control. The reset key is used to return the tape unit to manual control. Pressing the key removes the machine from ready status, if it has not already been removed, and stops whatever machine operation is in progress, except for unload. Once started the unload operation is always completed; the high-speed rewind operation is shifted into low-speed rewind. After the tape is loaded into the vacuum columns and low-speed rewind is in progress, press the reset key again to stop the low-speed rewind.

Reel Door Interlock: This interlock automatically prevents any normal operation of the tape unit when the door is open. The reel door should never be opened when the ready light is on or during any load-rewind operation.

Reel Release: Pressing this key permits the reels to be turned manually for threading tape when the reel door or power window is open.

Power Window

The reel door for the 2401-2404 Models 1-6 includes a tape access window that automatically opens following a tape unload and closes prior to a tape load operation. In addition to the operator key functions (previously described), key functions related to the power window are:

Load-Rewind: Pressing this key causes the power window to raise and close before starting the load-rewind operation. If any object prevents the power window from closing, it will operate the safety bail at the top of the reel door, which causes the window to reverse direction and lower until fully open. After removing the obstruction, press the load-rewind key again to reinitiate the load-rewind operation.

Unload: When the tape unit is loaded and not ready, pressing the unload key causes the power window to open after the tape has been unloaded from the columns.

Reset: This key may be used just to close the power window, e.g., when the tape unit is unloaded and idle. The window cannot be closed while the reel door is open.

OPERATOR LIGHTS—2401-2404 ALL MODELS

Select: This light is turned on automatically when the unit is addressed by the computer. The addressed tape unit must be ready before it can be instructed by the program.

Ready: When this light is on, it indicates that the tape unit is properly loaded, the start key has been pressed, and the tape unit can now be activated through the tape

control. The ready light is turned on by pressing the start key if:

1. Tape unit is loaded—tape in columns.
2. Reel door interlock is closed.
3. Tape unit is not in the process of finding load point.

Pressing the start key while the tape is in motion, as in a load-rewind operation, does not light the ready light until the load-rewind is completed. The reel door should not be opened when the ready light is on. Manual control is indicated when the ready light is off, if the tape unit is not rewinding or loading and the reel door is closed.

File Protect: When this light is on, it indicates that the loaded tape unit is file-protected; that is, neither writing nor erasing can take place on this tape unit. The file protect light is on when:

1. No file reel is mounted.
2. A file-protected tape reel is mounted.
3. A load-rewind operation is in progress.
4. An unload operation is in process.

The indicator is turned off by mounting a tape reel that is not file-protected. If the file protection ring has been removed and this light fails to go on, notify the customer engineer.

CB: When this light is on, it indicates that a circuit breaker has been tripped. The tape unit cannot operate until the circuit breaker has been reset by a customer engineer.

Tape Indicate: When this light is on, it signifies that an end-of-tape (EOT) marker has been sensed during a forward tape operation. The tape indicate light may be turned off (TI reset) by executing a backward tape operation, by pressing the unload key, by opening the reel door, or when the tape unit receives a rewind or rewind-unload command. See Figure 15.

TCU CB/TH: The 2403/2404 operator's panel has an additional light labeled TCU CB/TH. It is located next to the CB light and serves to indicate a dc circuit overload or thermal overload condition in the control unit.

OPERATOR KEYS—2415 ALL MODELS

Figure 30 shows the 2415 Operator Panel.

Load-Rewind: The purpose of this key is to ready the tape for reading or writing. With tape properly mounted in the tape unit, pressing this key causes tape to be loaded into the vacuum column and initiates a forward search terminating with the load point reflective marker at the read/write head.

With tape distributed on the reels, pressing the load-rewind key causes tape to unload from the vacuum column and rewind at high speed to load point. Do not hold this key depressed. Doing so will cause tape to

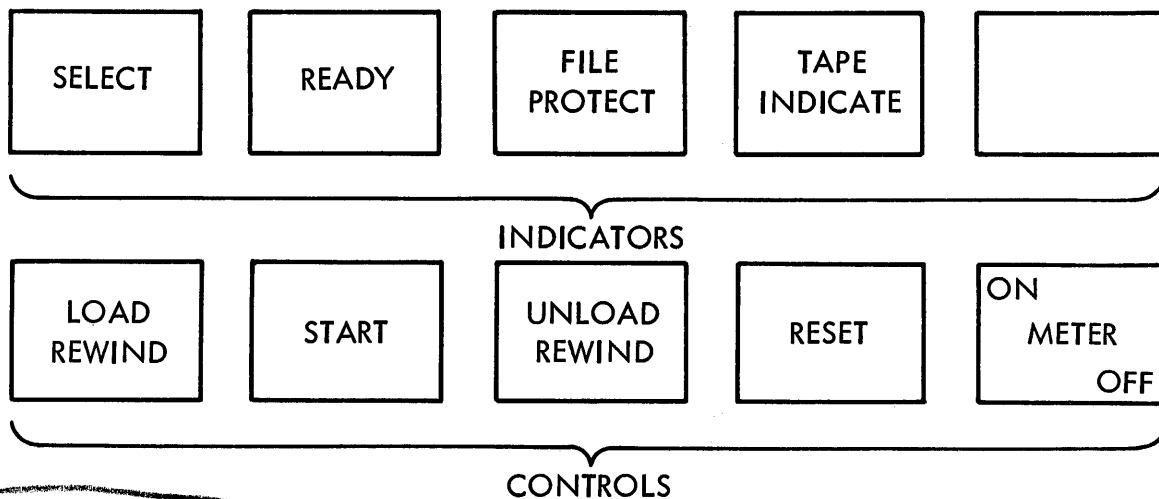

Figure 30. 2415 Operator Panel

reload and start a forward search for load point. Should this happen, press the reset key and again press the load-rewind key.

The load-rewind key is operative only when the reel door is closed and the ready light is off.

Start: Pressing this key places the tape drive under system control and turns on the ready light if:

1. The reel door and H-shield interlocks are closed.
2. The load-rewind key has been pressed.
3. Tape is in the vacuum column and load point has been sensed.

Unload Rewind: Pressing this key causes tape to be unloaded from the vacuum column and initiates a high-speed rewind that terminates with the load point reflective marker at the read/write head. This key is operative only when:

1. The ready light is off.
2. Tape is in the vacuum column.
3. Reel door is closed and H-shield is down (run position).

Reset: Pressing this key resets the tape unit from ready status to manual control, turns off the ready light and/or tape indicate light, and stops any tape operation previously started.

Meter Switch: (On the 2803 and 2804 marked "On/Off"): This switch places the tape control in an on-line or off-line state. The switch can be turned on or off any time, but the actual transition occurs only when the CPU enters a halt or wait state. At that time, if the switch is in the OFF position, the tape control will be rendered inoperative and not selectable by the program.

CAUTION

Be sure that all outstanding or pending status is accepted by the program (i.e. cleared from the tape control) before turning the switch off. For example, a program may be delayed if the TC is placed off-line while a tape unit is rewinding as the result of a rewind command previously given via that TC. The device end, normally presented when the tape unit reaches load point, will not be presented while the TC is off-line. The TC meter will not run when the TC is off-line. If, in addition, power is dropped on the TC, this DE and other status will be lost.

Reel Door Interlock: This switch automatically prevents normal operation of the tape unit when the reel door is open. The reel door should not be opened while the ready light is on or during any rewind operation.

Reel Release: Pressing this key permits the reels to be turned manually, e.g., for threading tape in the tape load procedure.

OPERATOR LIGHTS—2415 ALL MODELS

Select: This light is turned on automatically when the unit is addressed by the computer. The addressed tape unit must be ready before it can be instructed by the program.

Ready: When this light is on, it indicates that the tape unit is properly loaded, the start key has been pressed, and the tape unit can now be activated through the tape control. The ready light is turned on by pressing the start key. (See "Start Key.")

Pressing the start key while the tape is in motion, as in a load-rewind operation, does not light the ready light until the load-rewind is completed. The reel door should not be opened when the ready light is on. Manual control is permitted when the ready light is off, if the tape unit is not rewinding or loading and the reel door is closed.

File Protect: When this light is on, it indicates that the loaded tape unit is file-protected; that is, neither writing nor erasing can take place on this tape unit. The file protect light is on when:

1. No file reel is mounted.
2. A tape reel without a file protection ring is mounted.
3. A rewind operation is in progress.
4. The H-shield is raised.

The indicator is turned off by mounting a tape reel that has a file protection ring. If the file protection ring has been removed and this light fails to go on, notify the customer engineer.

Tape Indicate: When this light is on, it signifies that an end-of-tape (EOT) marker has been sensed during a forward tape operation. The tape indicate light is turned off (TI reset) by sensing EOT while executing a backward tape operation, by pressing the load-rewind or reset key, by opening the reel door, or when the tape unit receives a rewind or rewind-unload command. See Figure 15.

OPERATOR KEYS—2420 MODEL 7

Figure 31 shows the 2420 Operator Panel.

Load Rewind: Pressing this key initiates a rewind to load point. If the tape unit is unloaded, depressing the key causes the power window to close and initiates the automatic threading cycle to load point. If any object prevents closing of the power window, the safety bail at the top of the window will operate, causing the window

to reverse direction and lower until fully open. After removing the obstruction, the load-rewind key must again be depressed to reinitiate the load-rewind operation. The load-rewind key is inoperative if the tape unit is in ready status.

Start: Pressing this key places the loaded tape unit in ready status. Ready status is necessary before the tape unit can operate with the tape control. The start key is operative after the load-rewind key has been depressed.

Rewind Unload: This key is inoperative when the tape unit is in ready status. When not in ready status, pressing the rewind-unload key causes the tape to rewind and unload from the columns into the supply (file) reel, closes the cartridge (if used), and lowers the power window.

Reset: Pressing this key performs the following operations:

1. Puts the tape unit in manual control
2. Removes the tape unit from ready status and prevents operation through the tape control
3. Closes the power window if the tape unit is unloaded, idle, and the front door is closed (power window will not close if front door is open).
4. Slows tape from 500 ips to 200 ips when the key is “tapped” during high speed rewind (HSR). A second “tap” stops the tape. Stops tape immediately from 500 ips when the key is held depressed during HSR.
5. Turns off the load check indicator and closes the cartridge when the key is “tapped” following a load check.

Select: When on, indicates the tape unit is selected to perform a tape operation. The tape unit must be in ready status.

Ready: When on, indicates that the tape unit is in ready status, that is, tape is loaded (tape in vacuum columns and across read/write head), all interlocks are closed, and

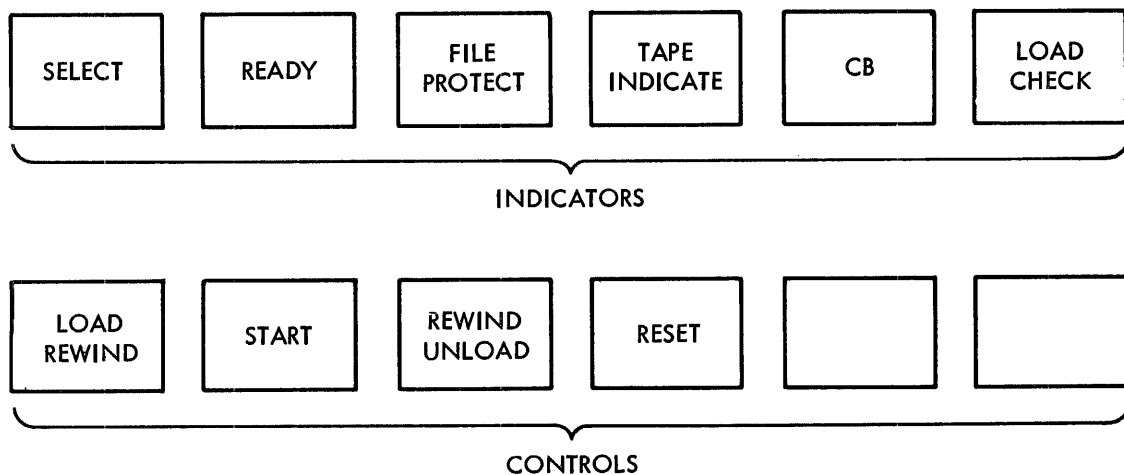

Figure 31. 2420 Operator Panel

tape is not rewinding. The light is turned on by depressing the start key, but it will not light unless the above two conditions are met. Depressing the start key while the tape is in motion, as in a load-rewind operation, will not light this indicator immediately, but the light will turn on when the load-rewind is completed.

File Protect: When on, indicates the loaded tape is file-protected, that is, neither writing nor erasing can take place on this unit because the file reel does not contact a write enable ring or the ready light on the drive is not illuminated.

Tape Indicate: Lights when the reflective EOT marker on the file reel operates the tape indicator photocell while in read or write status or if tape breaks. TI is reset when the EOT marker passes over the EOT sensor in the backward direction.

CB: When on, indicates a circuit breaker or the 'gate thermal' switch has been tripped. The tape unit cannot operate until the circuit breaker has been reset. (Also resets ready status.)

Load Check: When on, indicates a threading failure. This indicator is turned off by the reset key.

Tape Handling and Organization

MAGNETIC TAPE HANDLING

IBM magnetic tape is manufactured and tested under carefully controlled conditions to assure highest quality and reliability. An actual performance test is made on the entire length of each reel of tape. To assure the high quality of IBM magnetic tape is maintained with usage, rigid reliability and life tests are made.

Dust, dirt, or damage to the tape can reduce or prevent the necessary physical contact between the oxide surface of the tape and read/write unit. Signal strength may be sharply reduced, or recorded information may be completely obliterated.

Foreign particles, wear products, a crease, or any condition that causes the tape to be lifted as little as 1/1000 inch from the read/write head will cause the signal to fall below the effective sensitivity of the read/write unit.

Periodic cleaning of all tape units, particularly the read/write heads and transport mechanism, is required. (See "2400 Tape Transport Cleaning Procedure.") Cleaning is also desirable before beginning any extensive tape operation. IBM customer engineers discuss existing instructions and practices with customer personnel to insure safe and proper cleaning techniques.

Machine Room Housekeeping

Dirt and dust in the machine room can be a major source of tape trouble; it is absolutely necessary that all possible precautions be taken. The following suggestions are offered to minimize this potential problem.

Periodic Cleaning

The entire room should be vacuumed every 24 hours. For vacuuming under the various machine components, it is recommended that a nonconductor type of nozzle be used to minimize any possibility of an electrical accident. Either an external vacuum or an adequately sealed or filtered container within the room should be used. The entire floor should also be thoroughly cleaned every day with a damp mop. Under no circumstances can sweeping or the use of dust-cloths, dry mops, and the like be tolerated.

Floor Waxes

Keep waxing to a minimum. Some waxes tend to flake if not carefully applied, resulting in dust that can seriously jeopardize operating efficiency of the equipment. Any wax or other top dressing for the floor should be applied

very lightly. The floor should be machine buffed to remove excessive amounts of top dressing. Finally, the floor should be damp-mopped with cold water to harden the top dressing and machine-buffed again when dry. No steel wool or other metal abrasive should ever be used for buffing the floor.

Dust Prevention

While a reel of tape is on the machine, its container should be closed and placed where it is not exposed to dust and dirt. When a reel of tape is removed from a tape unit, immediately place it in a dust-proof container. Always place tape end retainers on the reels as they are stored, to prevent the free end from unwinding in the container.

Store tapes in a cabinet elevated from the floor and away from sources of paper or card dust. This should minimize the transfer of dust from the outside of the container to the reel during loading or unloading operations.

Never use the top of a tape unit as a working area. Materials placed on top of the units are exposed to heat and dust from the blowers in the unit. Interference with tape unit cooling will also result.

To label a reel of tape for identification, other than by means of the provided card holder, use a material that can be removed without leaving a residue. Adhesive stickers that can be applied and removed easily are satisfactory. Never use an eraser to alter the identification on a label.

Damage Prevention

Recorded information comes with 0.007 inch of the edge of nine-track tape. Tiny nicks and kinks caused by careless handling of the tape or reel may seriously affect the quality of magnetic reading or recording. Damaged tapes are as ineffective as chipped or broken phonograph records.

Tapes that contain useful information must not be exposed to magnetic fields with an intensity greater than 50 oersteds.

Smoking should not be permitted in the computer room. Under no circumstances should a person who is smoking handle tape, attend the tape units, or work in the tape storage area. Ashes can contaminate tape and live ashes can produce permanent damage if they touch the surface of the tape.

Irregular Winding

Tape will normally wind on the reel with some of its edges slightly protruding. These irregularities usually result from high-speed rewinding. The great speed at which tape moves during rewinding causes air to be trapped between adjacent layers of tape and produces the slightly irregular wind.

In itself, this condition will not interfere with proper operation of tape, but it requires that proper care in handling tape be exercised by all operating personnel. The exposed tape edges can be badly damaged by squeezing them through the reel openings, or by pinching the edges of the reel. Handle reels near the hub whenever possible. In picking up reels, grip the reel between the center hole and the outer edge.

Wavy Edge

Two conditions may give magnetic tape the appearance of having a wavy edge. One of these is a curvature. If a short length of tape is spread flat on a clean surface, its edge will not be perfectly straight but will show a slight curvature. This curvature should not exceed 3/16 inch in 36 inches of tape. Otherwise, the tape will tend to turn in the vacuum columns. A nominal curvature is present in almost all tapes.

Another condition that can cause magnetic tape to exhibit a wavy edge results from edge damage. If the tape reel is improperly mounted, the edge of the tape receives undue wear and becomes burred. This burr causes one edge of the tape to be slightly thicker than the other. When wound on a reel, the tape edge with the burr will wind to a larger diameter than the undamaged edge. In time, the edge of the tape with the burr will be permanently stretched. A tape in such condition proves unpredictable and generally unsatisfactory. Read errors, usually random and nonrepetitive, are encountered.

Reel Warpage

Reels must be properly supported when not in use. The plastic reel container is designed so that a reel is fully supported. A reel that is supported in any other manner may become warped.

One common reason for a reel to wobble or appear to be warped during use is that the reel may not be seated properly on the tape drive hub. The same effect is produced if the file protect ring is not inserted completely and the reel is prevented from seating. In either case, the reel behaves as if it is warped, and the edges of the tape can be damaged.

Dropping a reel of tape can easily damage both the reel and the tape. Never throw or mishandle reels, even while they are protected in their containers.

Cleaning Tape and Tape Containers

CAUTION

Tape transport cleaner should never be permitted to come into direct contact with IBM Dynexcel or HD magnetic tape because of interaction with tape and cleaner.

To clean Mylar tape, wipe it gently with a clean, lint-free cloth moistened with an IBM recommended tape transport cleaner. Carbon tetrachloride and vythene must not be used for cleaning magnetic tape under any circumstances. Clean IBM Dynexcel or HD tape by wiping with a clean, dry, lint-free cloth.

Periodic inspection of reel containers should be established. Remove any accumulation of dust by washing containers with a household detergent.

Dropped-Tape Inspection

If a reel of tape is dropped, the reel may be broken or bent (bending is less likely, as a strain sufficient to bend a reel usually breaks it), the edge of the tape may be crimped, and the tape may be soiled. Inspect the tape reel immediately. Breaking or bending of the reel can usually be found by visual inspection. In addition, check the reel for bending by mounting it on the hub of a tape unit. If the reel has been bent or broken, it must not be used again. The tape may be serviceable, however.

If there is no evidence of crimping or other tape damage, and the reel is undamaged, thoroughly clean the reel and the exposed or unwound tape. A damaged reel without evidence of tape damage should be discarded after the exposed or unwound tape is thoroughly cleaned and rewound on a good reel. If possible, test the tape for proper functioning before using it on subsequent runs.

If crimped tape contains essential information, thoroughly clean the tape and attempt to reconstruct this information through a tape-to-printer or other machine operation. If reconstruction fails, the tape records in question must be rewritten from cards or other source material. Discard crimped footage.

Retest Service for Magnetic Tape

The IBM retest service provides customers with the opportunity of salvaging a good tape that has been contaminated with removable defects.

Retest service enables customers to return reels of used IBM magnetic tape to the Magnetic Tape Testing Center for a complete retest at 556 or 800 bpi, or 3,200 flux changes per inch. All removable defects are eliminated from the tape, and the customer receives a report indicating the location of permanent defects, if any. If a reel of tape contains a nonremovable defect, the customer can elect one of four optional ways to have his tape returned with a report of the nonremovable defects. Further details may be obtained from the local IBM sales office.

Tape Library Records

A tape library may contain a few hundred reels or several thousand reels of magnetic tape. These reels contain vital company records, and an adequate and rigorous system of control is essential to the filing and maintenance of records on tapes.

A system for controlling the tape library provides for:

1. Means of quickly determining the location of any tape file in the library. A tape file may consist of one or more reels of tape, each reel identified by its reel serial number.
2. Recording the identity of the person to whom a file is charged when it is issued from the library.
3. Making tape reels available when their scratch date occurs.
4. Having library records that are concise, easily understood, and requiring a minimum of entries.

Many systems of organization may be suitable for controlling the tape library; procedures are influenced by the size and activity of the library. Three printed forms are suggested in the library system described below.

File History

Each file requires a file history (Figure 32). The jobs for which this file is used and the input tape units for those jobs are shown in the top left corner. The retention cycle entry indicates the number of days the file is to be retained after being written.

Each page accommodates a file of up to four reels. The serial number of each reel of the file is placed in the four columns provided. If there are more than four reels, a 1 is placed in the MORE column whenever an additional page is required. When an additional page is not required, an A is placed in the MORE column.

The date the file was written is entered in the DATE WRITTEN column. The EFFECTIVE DATE refers to the data in the file. For example, Friday's payroll might be run on Monday. Friday's date would be the EFFECTIVE DATE, and Monday's date would be the DATE WRITTEN.

Job No.		Tape Unit		FILE HISTORY TAPE LIBRARY				FILE NO. 362									
1723		0200						PAGE 1 OF 1									
1861		0202		ISSUED AND RETURNED				RETENTION CYCLE 21 days									
TAX TEN		0204															
SER. NO. OF REEL				More	Date Written	Effective Date	Scratch Date	To			Out			In			
1	2	3	4					To	Out	In	To	Out	In	To	Out	In	To
762	302	513		0	2/6	2/3	2/27	NY	2/7	2/7							

Figure 32. Sample File History Form

The scratch date indicates the date the reels may be issued as scratch (outdated) reels for use as an output tape.

Whenever a file is issued, an entry is made of the person's name, number, or initials, and the issuing date. When the file is returned, the return date is entered.

When a file is returned to the librarian, the file number and reel serial numbers should be matched against those on the sheet. When the reel serial numbers are different but the file number matches, a new entry line must be made in the file history and the reel history, because the file has been updated and written on different reels. The old file, which was checked out, must be returned and checked in on the proper line.

The returned reels are then placed in their proper location in the storage cabinets, according to a serial number sequence.

Reel History

Each reel of tape in the library has a corresponding reel history record (Figure 33), based on the serial number assigned to the reel. This history records the numbers of the files that have been written on a reel. It also indicates the read errors reported on the reel, the age of the tape, and the current length of the tape.

When an entry is made on a new line of the file history, a new line is begun in the reel history for each reel of the file.

REEL HISTORY TAPE LIBRARY			REEL SERIAL NO. 762	
			Date Received:	12/1/60
			Present Length:	1200 ft
FILE	REEL	OF	Date Written	Read Errors and Remarks
106	2	3	12/5/60	None
362	1	3	2/6/61	None

Figure 33. Sample Reel History Form

TAPES AVAILABLE AS OF THIS DATE 2/27/67

TAPE LIBRARY

Reel Serial No.	Reissued To	Date	For Job
762	FRC	2/28/67	2309
302	BN	3/3/67	2400
513	NY	3/6/67	2550

Figure 34. Sample Tape Available Form

Tapes Available

An entry is made on one of the tape's available pages (Figure 34) whenever a new entry line is made on any file history page. One of the entries on the new entry line in a file history is the scratch date. The serial number of the reel entered in the file history is also entered on the tape's available page for the date corresponding to the scratch date entered in the file history.

When the date of a page becomes the current date, the tapes listed on that page become available and may be issued as scratch tapes. At that time, an entry is made showing to whom the tapes were issued, the date, and the

job numbers for which they will be used as output tapes.

When the librarian receives a request for a particular tape file, he refers to the file history to determine if the tape has been checked out. If not, he notes the serial numbers, procures the reel(s) from the storage cabinet, checks them out, and issues them.

When the librarian receives a request for a reel of tape by its serial number, he may first look where it is kept. If it is missing from the cabinet, he may refer to the reel history to determine the number of the last file written on the reel. The file history may be used to ascertain to whom the reel has been issued. If the scratch date has been reached, the tape's available record for that scratch date may then be used to learn to whom the reel has been issued and the job upon which it is being used.

When issuing scratch tapes from the tape's available records, the tapes that have been available the longest should be issued first. Thus, the librarian may be issuing scratch tapes from a tape's available page that is several weeks older than the current date page.

It may be desirable to maintain all tapes for a particular application in one area of the library storage cabinets by allocating blocks of reel serial numbers to the applications.

Appendix A — Procedures

TAPE LOAD PROCEDURE—2401-2404

To load tape (see Figures 35 and 36):

1. Open the left hub latch by pulling tab toward you. Mount the reel on the left mounting hub. To ensure proper alignment, place the hub of the reel firmly against the stop on the machine mounting hub, and close the hub latch. Always check to ensure that the hub latch is closed.
2. Hold the reel release key depressed and rotate the file reel clockwise, unwinding about 4 feet of tape.
3. Place the tape around the left rewind idler, through the read/write assembly, and around the right rewind idler. To load reels with cut-out areas in the front flange, place and hold the end of tape between the index finger and the hub of the mounted machine reel. Press the reel release key, and wind tape on the machine reel clockwise for at least two turns beyond the load point marker. Align the tape carefully on the machine reel to prevent damage to the edge on the first few turns. Use the reel finger hold when winding the tape. Rotating the reel by using the cut out area can result in damage to the edge of the tape. To load reels without cut out areas in the front flange, place a short loop of tape over the machine reel hub, then spin the reel

clockwise until it grips the tape. Wind about two turns past the load point marker.

4. Close the reel door, if open.
5. Press the load-rewind key. This closes the power window, loads tape into the vacuum columns, lowers the head assembly, and rewinds tape to load point.
6. Press the start key. This places the tape unit under automatic control and turns on the ready light.

TAPE UNLOAD PROCEDURE—2401-2404

1. If the ready light is on, press the reset key to return the unit to manual control.
2. Press the load-rewind key to rewind the tape.
3. When the load point is reached, press the unload key. This raises the head, unloads tape, and lowers the power window.
4. Hold the reel release key depressed and manually rewind the file reel by turning it counterclockwise with the finger pressed in the finger hold of the tape reel.
5. When the tape is completely rewound, open the hub latch and remove the reel. If resistance is encountered in removing a reel, exert pressure from the rear of the reel with the hands as near the hub

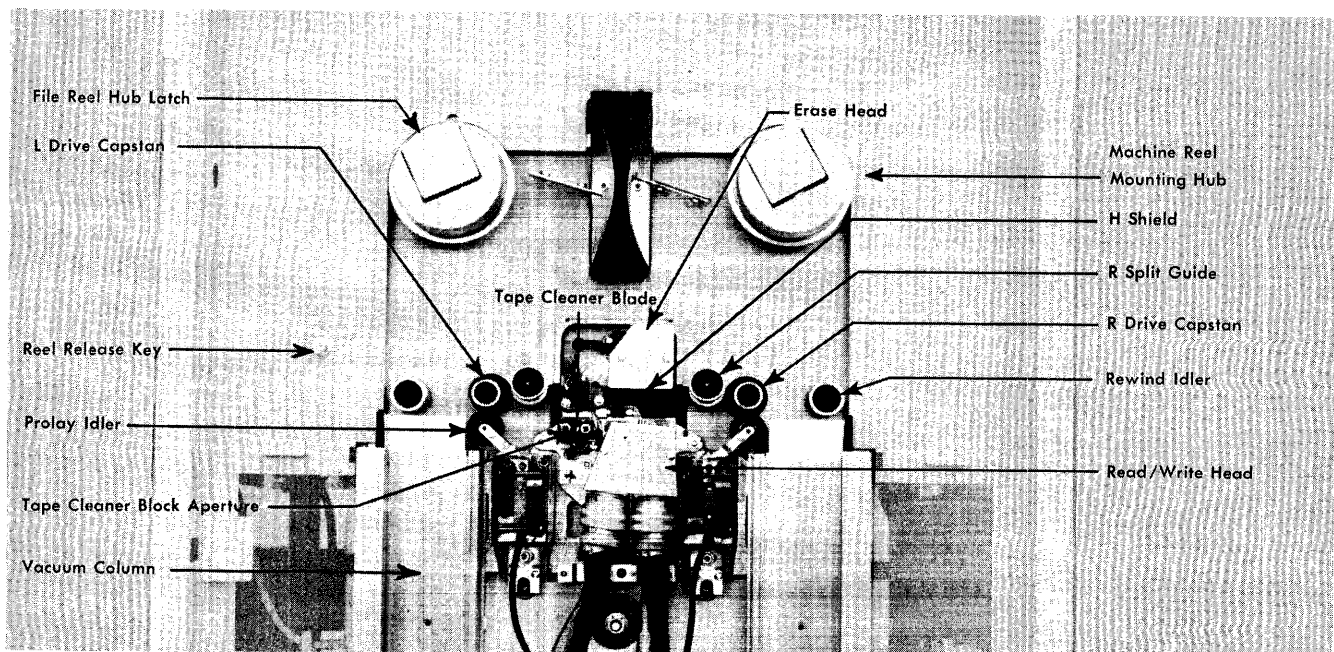

Figure 35. 2401-2404 Tape Transport — Model 1 or 4

as possible. Never rock a reel by grasping it near the outer edge in a way that pinches the edges of the outer turns of the tape.

Note: Do not turn power off with the tape unit in a load status; because the head assembly must be up for removal of the tape.

2400 TAPE TRANSPORT CLEANING PROCEDURE

The tape transport (Figures 35, 36, and 37) should be thoroughly cleaned at intervals shown in Figure 38.

CAUTION

When cleaning the transport area care must be taken to prevent any IBM tape cleaner (IBM P/N 517960) from coming in contact with the skin, as a toxic effect may result. Also, prevent any tape cleaner from getting on the bearings and bushings, because it will leach oil from them. Do not use any metal instrument to clean the vacuum columns.

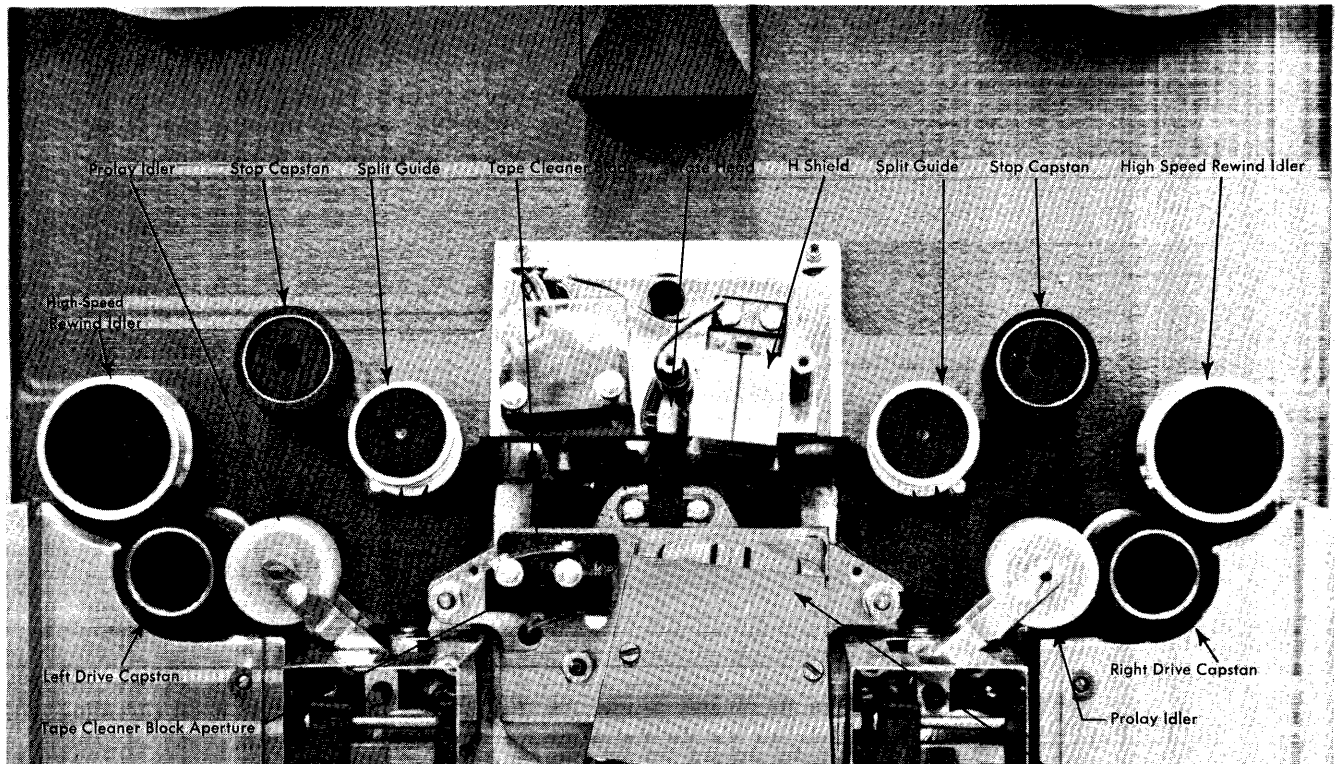

For efficient cleaning, tools are available in a tape transport cleaning kit (IBM P/N 352465).

To clean the tape transport area:

1. Unload tape from the tape unit. At no time should the reel door interlock switch be pressed.
2. Remove dust from reel and transport area with a lint-free cloth, P/N 2108903
3. Clean the split guides carefully (2415, head tape guides) with a small brush (IBM P/N 556945) or a clean typewriter brush. Remove accumulated oxide from the surface of guides and between the elements with a lint-free cloth moistened with tape transport cleaner.
4. Clean H-shield and erase head (2401-2404) with a lint-free cloth moistened with tape transport cleaner.
5. Clean tape cleaner blade with a small brush (IBM P/N 556945) using light pressure to avoid damaging the cleaner blade. If necessary, moisten the brush slightly with tape transport cleaner to remove stubborn oxide clumps. Clean out the tape cleaner block aperture with a cotton swab. Be sure that no cotton fiber remains.
6. Clean the rewind idlers (2415, column guide rollers) with a lint-free cloth moistened with tape transport cleaner. Use the nylon probe, P/N 2507587, to remove stubborn oxide clumps.
7. Clean capstans with a lint-free cloth moistened lightly with tape transport cleaner. Never touch cleaned 2420 capstan surfaces with bare fingers, and never load tape until capstan is wiped dry with a lint-free cloth.

CAUTION

Excessive amounts of tape transport cleaner may deteriorate the capstan material.

8. Clean the prolay idlers with a lint-free cloth moistened with tape transport cleaner (2401-2404 only).
9. Clean R/W heads with a lint-free cloth moistened lightly with tape transport cleaner. Wrap the cloth around a cotton-tipped swab for easier head access on 2415 tape units.
10. Clean vacuum columns weekly by using a lint-free cloth moistened with tape transport cleaner. Use the nylon probe (P/N 2507587) for 2401-2404 and 2415 tape units and a small brush (P/N 556945) or a typewriter brush for the 2420 tape unit to remove stubborn oxide clumps. *Do not use any hard instrument to clean 2420 vacuum columns, because the glass-bead coating will be damaged.*
11. Clean 2420 tape unit threading channels, tapered columns, and air bearings with a small brush or typewriter brush. Remove accumulated oxide with a lint-free cloth moistened with tape cleaner.

TAPE LOAD PROCEDURE—2415

To load tape (see Figure 37):

1. Open the left hub latch by pulling tab toward you. Mount the reel on the left mounting hub. To ensure proper alignment, place the hub of the reel firmly against the stop on the machine mounting hub, and close the hub latch. Always check to ensure the hub latch is closed.
2. Manually raise the H-shield.
3. While holding the reel release key depressed, pull the end of the tape up and over the left column guide rollers; thence over the left head tape guide, between the read/write head and H-shield; over the right head tape guide, capstan, and right column guide roller. For loading reels with cut out areas in the front flange, place and hold the end of tape between the index finger and the hub of the mounted machine reel. Press the reel release key, and wind tape on the machine reel clockwise for at least two turns beyond the load point marker. Align the tape carefully on the machine reel to prevent damage to the edge on the first few turns. Use the reel finger hold when winding tape. Rotating the reel by using the cut out area can result in tape edge damage. For loading reels without cut out areas in the front flange, place a short loop of tape over the machine reel hub, then spin the reel clockwise until it grips the tape (use the finger hold). Wind about two turns past the load point marker. The load point marker must be situated *left* of the read/write head.
4. Manually lower the H-shield.
5. Close the reel door.
6. Press the load-rewind key. This loads tape into the vacuum columns and winds tape forward to the load point marker.
7. Press the start key to place the tape unit under program control and turn on the ready light.

Note: Neither the vacuum column cover nor the head cover on the 2415 should be open while threading tape, because tape edges may be damaged.

TAPE UNLOAD PROCEDURE—2415

1. If the ready light is on, press reset key to return unit to manual control.
2. Press unload-rewind key to rewind tape.
3. Open reel door. Manually raise H-shield. Hold reel release key depressed, and manually rewind file reel by turning it counterclockwise with the finger pressed in the finger hold of the tape reel.
4. When tape is completely rewound, open the hub latch and remove the reel. If resistance is encountered in removing a reel, exert pressure from the rear of the reel, with the hands as near the hub

as possible. Never rock a reel by grasping it near the outer edge in a way that pinches the edges of the outer turns of the tape.

TAPE LOAD PROCEDURE—2420

The 2420 Model 7 is an automatic threading machine and requires minimal tape handling by the operator. Tape need not be touched at all if a tape reel cartridge is used. *Note:* To ensure satisfactory automatic threading operation, the BOT (Beginning of Tape) marker should be

located no further than 16 feet from the leading end of the tape (recommend 10-16 feet). Leader lengths in excess of 16 feet may result in deterioration of performance, and leader lengths in excess of 30 feet or less than 7 feet will not load successfully. The 2420 is designed to prevent runaway if tape is mounted without a BOT marker, hence the 30-foot restriction on leader length. There must be no wrinkles, dirt, adhesives or oil on the tape's end portion, and tapes which have been used on manual-threading drives should be trimmed with a special cutting-embossing tool, P/N 2512063.

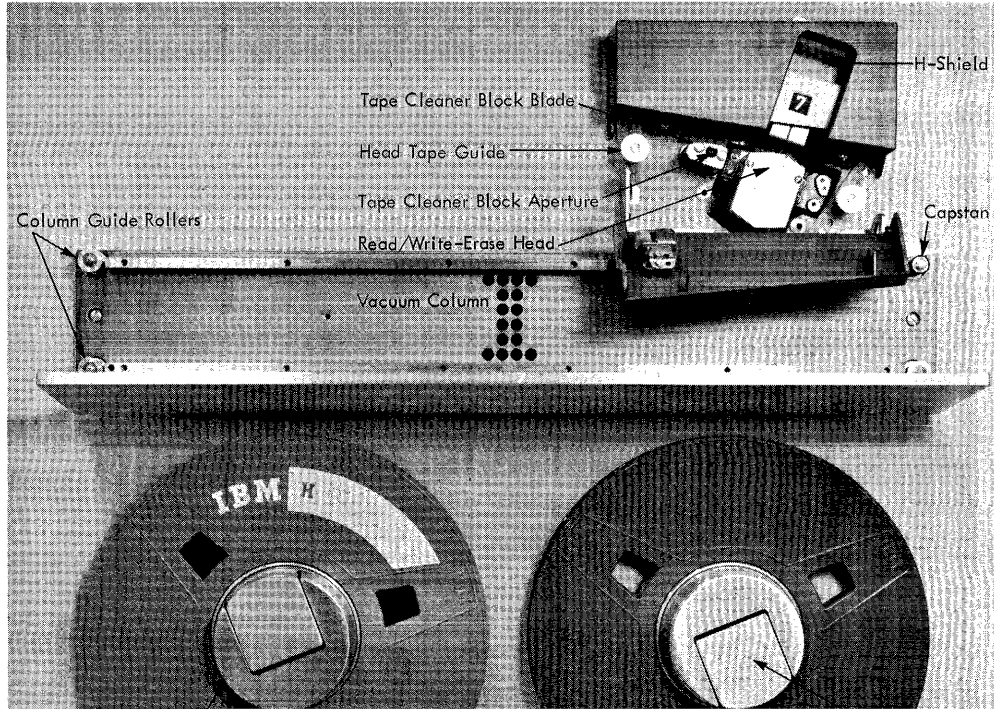

Tape Load Procedure With Cartridge

1. Open the right hub latch by pulling the tab toward you.
2. Mount the reel with cartridge. Be sure that the reel is flush with the reel lock back flange. Close hub latch. *Always check to be sure that the hub latch is closed.*
3. Press the load-rewind key. The power window closes; tape threads, loads into columns, and stops at load point automatically.

Note: Both reels turn clockwise during thread; and if tape is not threaded, a rewind is initiated, and a second thread attempt is made automatically. A second threading failure stops the machine and turns on the load check light.

4. Press the start key. The ready light comes on when the load operation is complete and the machine is ready (key may be pressed any time after pressing the load-rewind key). The TU is now under program control.

Reel-in-Cartridge Insertion

1. Hold both the reel and the cartridge vertically (to prevent tape entanglement) with the cartridge clip; open and twist the reel counterclockwise inside the cartridge to smooth and straighten tape.
IMPORTANT: Do not leave the tape end near or over the cartridge tape exit, because the tape end may be pinched and damaged when the cartridge clip is closed.
2. Close the cartridge clip.

Tape Load Procedure Without Cartridge

1. Open the right reel hub latch by pulling the tab toward you.
2. Mount tape reel with tape hanging on the right side. Be sure that the reel is flush with the reel lock back flange. Close hub latch. *Always check to be sure that hub latch is closed.*
3. Place the leading edge of tape in the guide at the reel's lower right.
4. Press the load-rewind key. The power window closes; tape threads, loads into columns, and stops at load point automatically.

Note: Both reels turn clockwise during thread, and if tape does not thread properly, the TU stops. The operator should manually rewind tape and repeat steps 3 and 4.

5. Press the start key. The ready light comes on when the load operation is complete, and the machine is ready (key may be pressed any time after pressing the load-rewind key). The TU is now under program control.

TAPE UNLOAD PROCEDURE—2420

1. If the ready light is on, press the reset key to return unit to manual control.
2. Press the rewind-unload key, and tape rewinds and unloads from the columns onto the supply (file) reel, closes the cartridge (if used), and lowers the power window.

AC AND DC POWER DISTRIBUTION

Power Off/Power On—2400 Units

AC: Be sure the channel is not active while ac on/off powering a 60-Hz control unit when more than one control unit is connected on-line to the interface.

DC: Use procedures attached to each control unit for dc on/off powering a 60-Hz unit equipped with the isolation feature when the unit is attached to an active channel. Both ac and dc on/off powering are possible on 50-Hz units equipped with the isolation feature.

If dc power is turned off at a tape unit that contains a terminator, all other tape units in the line are affected.

2401 Magnetic Tape Unit

1. Ac power is supplied by the control unit to all attached 2401 tape units.
2. Dc power is supplied by an individual dc power supply in each tape unit.

2402 Magnetic Tape Unit

1. The two units of a 2402 share common ac and dc power. If ac power is to be removed from a relay gate in either unit, both units must first be reset. After the power plug is removed for one unit, the other unit may be returned on-line by pressing the start key.
2. The dc power to the two units can be independently switched on and off. Dc power may be dropped on one unit without affecting the other but cannot be brought back up unless the other unit is reset.
3. One unit can be serviced while the other is operating unless the problem is in the ac or dc power distribution.
4. If dc power is dropped on both units, ac power must also be dropped.

2403 and 2404 Magnetic Tape Units and Controls

1. The control and tape unit of a 2403 and 2404 share common ac and dc power.
2. The ac and dc power to the tape unit can be switched on and off without affecting the tape control provided the tape unit is reset during the switching period, and dc power is maintained on the control unit.

3. The tape unit can be serviced independently of the control unit.
4. If ac power to the control unit is down, all tape units attached to the control unit also lose power if no 2816 Switching Unit is used.
5. If dc power in the control unit is off (ac power on), all tape units attached to the control unit are inoperative.
6. If dc power in the control unit is down, all tape units attached to control unit (except the one in 2403 and 2404) can be switched by means of a 2816 Switching Unit to another tape control. Dc power must be maintained on the tape unit within the 2403 and 2404 on 60 Hz units with the isolation feature.
7. If the 2403/2404 machines have the isolation feature, dc can be dropped on the TC without dropping it on the TU.

2400 TAPE TIMINGS

When processing is tape-limited, the required time to perform read, read backward, and write commands is equal to: number of bytes (including check characters and sync bytes) multiplied by the time per byte, plus interblock time. See Figure 39 for timings. See also Figures 8 and 10.

2400 TAPE ERROR RECOVERY PROCEDURES

This section describes the error conditions that can occur while operating the 2400-series tape units and prescribes the minimum recovery actions implemented to achieve acceptable performance and read/write reliability.

GENERAL CHARACTERISTICS

These procedures provide uniform recovery actions independent of operating systems or equipment models and prescribe additional recovery interfaces.

Whether CRP is in progress or not, all errors should be treated as defined in this procedure (except for load point) during a cleaner positioning (Action V).

OPERATIONAL CHARACTERISTIC REQUIREMENTS

An I/O error causes an interrupt condition. The error causing the interrupt is indicated in the channel status word (CSW). If the interface control check (Bit 46) or channel control check (Bit 45) is present in the channel status, do Action 1b. If Unit Check (Bit 38) is present in the CSW, a sense command must be performed prior to any other operation to the control unit to obtain further information about the error interrupt.

Figure 40 shows the sequence in which status and sense bits must be checked and indicates the required action.

Note: For a 2415 used with a Model 20, a similar sequence and action is required (see the section entitled "Operational Characteristics Requirements—Model 20"). p 53

Operator Messages

The operator message issued for these procedures must contain the following information:

1. A message code
2. Channel, control unit, and device addresses
3. The command in progress when the error occurred
4. The error condition which caused the message
5. All status and sense bits.

Action Requirements (Figure 40)

Terminal Action 1a (with Operator Option)

An operating system may provide either or both of the following facilities at this point.

1. Operator control interface
2. Additional programmed recovery interface.

If both are defined, exit to the operator control interface first.

Some of the operator control interface options which may be defined are:

1. Retry the recovery procedure
2. Continue to additional programmed recovery interface.

Terminal Action 1b (without Operator Option)

If the additional programmed recovery interface is defined, exit to it.

Action II (Unit Check)

Perform a SENSE command (unless already performed), and continue checking as shown on the chart. (The CSW information must be moved to a work area prior to this command.)

Action III (Intervention Required)

No Device End in Unit Status: Test for TU Status B (sense byte 1, bit 2). If TU Status B is off, the device is non-existent. Provide operator message, post completion with error condition, and exit to operating system. See Action 1a.

If TU Status B is on, provide an operator intervention required message, and reissue the command when the drive is made ready.

Device End in Unit Status: If the command was rewind-unload, continue processing. Otherwise, ignore the intervention-required condition and continue checking as indicated in the chart.

WITH PE TAPE CONTROLS (2803/2804 MODEL 2)					WITH NRZI TAPE CONTROLS 2803/4 MOD 1			2415
	2401-2402			2420	2401-2404			MODEL 1-6
	MODEL 1 or 4	MODEL 2 or 5	MODEL 3 or 6	MODEL 7	MODEL 1	MODEL 2	MODEL 3	
When writing or reading from load point, add: Forward/Backward Motion Change (ms)* (to be added if appropriate)	320ms	64ms	48ms	45ms	350ms	75ms	48ms	204ms
fwd/bkwd-after read	224	16	16	16	264	32	16	205 ^{††}
fwd/bkwd-after write	236	20.8	20.8	20.8	276	36.8	20.8	243
bkwd/fwd-before read	224	16	16	16	264	32	16	205
bkwd/fwd-before write	236.2	22.4	21	16	264	32	16	205
Write tape mark order time from initiation to disconnect: (In ms)								
7-track	104.4 ‡	52.2 ‡	34.8 ‡	NA	103ms	51ms	35ms	219
9-track, 800 bpi	100.0	50.5	33.5	NA	44ms	49ms	33.5ms	219
9-track, 1,600 bpi	101.2 #	50.0 #	33.7 #	30ms	NA	NA	NA	220 #
Rewind order disconnect time †	30ms	30ms	30ms	25usec	30ms	30ms	30ms	30usec
Rewind-unload order disconnect time	45ms	45ms	45ms	1 ms	45ms	45ms	45ms	30usec
Tape rewind, full reel (minutes)	3.0	1.4	1.0	1.0	3.0	1.4	1.0	4.0
Rewind-unload, full reel (minutes)	2.2**	1.5	1.1	1.1	2.2**	1.5	1.1	4.0

† With tape at load point rewind disconnect time is immediate.

†† The 2415 is in forward status after rewind or manual load.

* The tape unit maintains the status (forward/backward) of the operation it has performed. Forward/backward status change time must be added for every forward following a backward operation, every backward following a forward operation, and for every forward operation initiated at load point.

** Rewind unload takes less time than rewind in the Model 1 or 4 because tape is wound to load point at high speed. Rewind requires reloading tape. In both Models 2 or 5, and 3 or 6, tape is reloaded during a rewind-unload at the end of high-speed rewind and rewound to load point at low speed; it is then unloaded again (rewind does not require final unloading).

‡ The seven track feature is not installed on Models 4-6.

Models 1-3 - Not applicable.

M O D E L	TIME/BYTE (USEC)									
	2420	2401-2404*					2415			
	NINE- TRACK	NINE- TRACK		SEVEN-TRACK			NINE- TRACK	SEVEN-TRACK		
		1600 bpi	1600 bpi	800 bpi	556 bpi	200 bpi		800 bpi	556 bpi	200 bpi
1	NA	NA	33.3	33.3	48.0	133.0	66.6	66.6	95.9	266.4
2	NA	NA	16.7	16.6	24.0	67.0	66.6	66.6	95.9	266.4
3	NA	NA	11.1	11.1	16.0	44.0	66.6	66.6	95.9	266.4
4	NA	16.7	33.3	NA	NA	NA	33.3	66.6	95.9	266.4
5	NA	8.3	16.7	NA	NA	NA	33.3	66.6	95.9	266.4
6	NA	5.6	11.1	NA	NA	NA	33.3	66.6	95.9	266.4
7	3.1	NA	NA	NA	NA	NA	NA	NA	NA	NA

*There is no 2404 Models 4-6

NA = Not Applicable.

M O D E L	NOMINAL INTERLOCK GAP (MS)*					
	2420	2401-2404**			2415	
	NINE- TRACK	NINE- TRACK	SEVEN- TRACK	NINE- TRACK	SEVEN- TRACK	
						1600 bpi
1	NA	16.0	20.0	32.0	40.0	
2	NA	8.0	10.0	32.0	40.0	
3	NA	5.3	6.6	32.0	40.0	
4	NA	16.0	NA	32.0	40.0	
5	NA	8.0	NA	32.0	40.0	
6	NA	5.3	NA	32.0	40.0	
7	3.0	NA	NA	NA	NA	

* The normal IBG, attainable in normal start/stop operation during write, is 0.6 inches for nine-track tape and 0.75 inches for seven-track tape. The IBG can vary from 0.5 to 0.8 inches on a properly adjusted nine-track drive (0.68 to 0.98 inches on a properly adjusted seven-track drive) when a new write command is issued before the tape comes to a complete stop.

**There is no 2404 Model 4-6.

NA = Not Applicable

Figure 39. 2400 Series Tape Unit Timing Charts

Priority	Status Bit	Sense		Condition	Read	Applicable To		Action
		Byte	Bit			Write	Control	
1	38			Unit Check	x	x	x	II
2		0	3	Equipment Check	x	x	x	X
3		0	2	Bus-Out Check	x	x	x	IV
4		0	1	Intervention Required	x	x	x	III
5		0	0	Command Reject	x	x	x	XIII
6		0	5	Overrun	x	x		VII
7		1	4	Load Point	x		x	XII
8		0	4	Data Check	x			V
8		0	4	Data Check		x		VI
8		0	4	Data Check			x	VIII
9	44			Channel Data Check	x	x	x	VII
10		0	7	Data Converter Check	x			XIII
11		1	7	Not Capable	x			IX
12				No Previous Sense Bits On	x	x	x	X
13	47			Chaining Check	x			VII
14	42			Program Check	x	x	x	XII
15	43			Protection Check	x	x		XII
16	41			Incorrect Length	x	x		XII

● Figure 40. Status and Sense Indicator (Bits) Checking Sequence

Action IV (Bus Out Check)

No Device End in Unit Status: Reissue the command.

Device End in Unit Status: If this condition occurs during a write, reposition the tape and reissue the command. For all other commands, reissue the command.

Repeat this procedure until five retries have been attempted. If the error persists, provide operator message, post completion with error condition, and exit to operating system. See Action 1a and "Supplementary Information."

Action V (Data Check on Read or Read Backwards)

Recovery must determine if the block is a noise block; if not, retry 40 times in the same direction (as original CCW) and 40 times in the opposite direction, with cleaner actions every fourth retry. The steps are as follows:

Step 1: Determine if the block should be classified as a noise block (noise bit off and is less than the minimum block length of 12 bytes). If the noise bit (sense byte 1, bit 0) is on or if the block length meets or exceeds the minimum length requirements, the read operation should be retried, using steps 1 through 19.

Block length can be determined as follows:

1. If not data chaining, the CCW count less the CSW residual count must meet or exceed 12.
2. If data chaining and independent of the count in the first CCW, and the chain broke after the first CCW, assume block length requirements have been met.

3. If data chaining, the count in the first CCW is less than 12 and the chain broke before the second CCW, block length does not meet or exceed 12.
4. If data chaining, the count in the first CCW is equal to or greater than 12 and the chain broke before the second CCW, the first CCW count less the CSW residual count must be equal to or greater than 12.

Step 2: Set the correct mode (if seven-track), and reposition the tape.

Step 3: Set the correct mode (if seven-track), and send the track-in-error information (sense byte 2) to the control unit with a TIE command (if nine-track NRZI).

Note: For program simplicity, the mode set and TIE commands in this sequence may be issued whether required or not.

Step 4: Reissue the read or read backward command.

Note: TIC is the only command that may be executed between steps 3 and 4, because commands to the control unit may destroy the track-in-error and mode set information. Correction of a block should be attempted using only the track-in-error information from that block (if nine-track NRZI).

Step 5: Repeat steps 1 through 4 until the block is read successfully or a minimum of 40 retries (41 reads) have been attempted.

After every fourth re-read (step 4), the block in error should be passed by the tape cleaner blade.

Note: Tape cleaner positioning for a *forward* read is five backspaces, followed by four forward spaces. For a *backward* read, tape cleaner positioning is four backspaces, followed by five forward spaces. If load point is reached in "n" backspaces during a tape cleaner positioning, reposition for a read forward with "n-2" forward spaces; reposition for a read backward with "n" forward spaces. If a tape mark is encountered during a tape cleaner positioning, the unit exception indication should be ignored, and the tape mark should be treated as a normal block.

Step 6:

Note: This is the minimum read opposite recovery procedure. However, this specification does not exclude other methods which may prove to be more optimum for a particular operating system.

Should the error persist, determine if:

- a. Data chaining is being performed. *Note:* This specification does not prohibit read opposite recovery from this case. It is, however, judged an allowable exclusion based on the amount of additional ERP code required for read opposite recovery in this situation.
 - b. Data converter mode set is being used and seven-track TU is in the sense data (byte 1, bit 3).
 - c. Suppress data transfer bit is set in the failing read CCW.
- If any of these conditions is met, provide an operator message, post completion with error condition, and exit to operating system. If none of these is met, proceed to Step 9. See Action 1a and "Supplementary Information."

Step 7: Determine if the block should be classified as a noise block. See Action V, step 1.

Step 8: Set the correct mode (if seven-track), and reposition the tape.

Step 9: Set the correct mode (if seven-track), and send the track-in-error information (sense byte 2) to the control unit with a TIE command (if nine-track NRZI).

Step 10: Issue a read command in the direction opposite (read opposite CCW) with the suppress data transfer bit on.

Step 11: Repeat steps 7 through 10 until the block is read successfully or a minimum of 40 retries have been attempted. If the block is read successfully, note the remainder of the 40 retries and go to step 12. If, after attempting 40 retries, the read opposite CCW is still unsuccessful, go to step 19.

After every fourth re-read (step 10), the block in error should be passed by the tape cleaner blade. See note after step 5.

Step 12: If the actual block count is greater than the failing original read CCW count, proceed to step 19.

Note: This specification does not prohibit read opposite recovery from this case. It is, however, judged an allowable exclusion based on the amount of additional ERP code required for read opposite recovery in this situation.

If the actual block count is equal to or less than the failing read CCW count, compute the correct data address, count for read opposite CCW, and proceed to step 13.

Step 13: Determine if the block should be classified as a noise block. See Action V, step 1.

Step 14: Set the correct mode (if seven-track). Reposition the tape.

Step 15: Set the correct mode (if seven-track) and send the track-in-error information (sense byte 2) to the control unit with a TIE command (if nine-track NRZI).

Step 16: Issue the read opposite CCW with the computed address, count, and the suppress data transfer bit off.

Step 17: Repeat steps 13 through 16 until the block is read successfully or the remainder of the 40 retries have been attempted. If the block is read successfully, go to step 18. If, after attempting 40 retries, the read opposite CCW is still unsuccessful, go to step 19.

After every fourth re-read (step 16), the block in error should be passed by the tape cleaner blade. See note after step 5.

Step 18: Set the correct mode (if seven-track), reposition the tape over the error block, post completion without error condition, and continue with normal processing.

Step 19: Set the correct mode (if seven-track), reissue the read or read backward command. If the error persists, provide an operator message, post completion with error condition, and exit to operating system. See Action 1a and "Supplementary Information."

Action VI (Data Check on Write and Write Tape Mark)

Reposition the tape, issue an erase gap (ERG) and reissue the command. Repeat this procedure until 15 retries have been attempted. If the error persists, provide an operator message, post completion with error condition, and exit to operating system. See Action 1a and "Supplementary Information."

Note: This action is designed for the maximum length of 32,768 bytes at 800 bpi.

Action VII (Overrun, Channel Data Check, Chaining Check)

If one of these conditions occurs during a read or write, reposition the tape and reissue the command; if this is a control command, reissue the command. Repeat this procedure until five retries have been attempted. If the error persists, provide an operator message, post completion with error condition, and exit to operating system. See Action 1a and "Supplementary Information."

Action VIII (Data Check on Control)

If the command is a write tape mark (WTM), execute Action VI. If the command is an erase gap (ERG), reissue the command. Repeat this procedure until three retries have been attempted. If the error persists, provide an operator message, post completion with error condition and exit to operating system. See Action 1a.

Action IX (Not Capable)

Reposition the tape to load point, provide an operator message, post completion with error condition, and exit to operating system. See Action 1a.

Note: Retries may be made at user option; otherwise, it is recommended that an alternate reel be mounted and processed.

Action X (Equipment Check)

Tape position is indeterminate; provide an operator message, post completion with error condition, and exit to operating system. See Action 1a.

Action XI

Provide an operator message, post completion with error condition, and exit to operating system. See Action 1a.

Action XII

Post completion with a check condition, and exit to operating system. See Action 1b and "Supplementary Information."

Action XIII

Provide an operator message, post completion with check condition, and exit to operating system. See Action 1b. Also see "Supplementary Information" for command reject and data converter check.

Supplementary Information

Bus Out, Overrun, Data Check on Reads and Writes, Channel Data Check, and Chaining Check

The additional programmed recovery might include the use of alternate path retry.

Command Reject, Program Check, Protection Check, Incorrect Length

If the additional programmed recovery is to allow the task to abnormally terminate, suitable comment should be provided on the source of the termination.

Load Point

Normally, load point is used as a data set delimiter and, thus, is provided for in the additional programmed recovery. If it is an unexpected condition and the task is allowed to abnormally terminate, suitable comment should be provided on the source of the termination.

Data Converter Check

This check occurs on binary tapes not generated by the data converter feature and is used to adjust the final bytes of the block. Normally, this condition should be provided for in the additional programmed recovery.

**OPERATIONAL CHARACTERISTIC REQUIREMENTS—
MODEL 20**

Error recovery procedures for 2415 Tape Units used with a Model 20 are the same as described in the previous section except where noted below.

If interface control check is present in the CSW, do Action Ib in the previous section.

Unit Check is bit 14 in the Model 20 CSW.

Figure 41 is a complete replacement for Figure 40 when using a 2415 on the Model 20. Actions referred to are in the previous section except Actions Va and VIa, which are listed below.

Action Requirements—Model 20 (Figure 41)

Action Va: Data Check on Read or Read Backwards

Step 1. Test the noise bit (sense byte 1, bit 0). If the noise bit is off, test the block size to determine if it meets or exceeds minimum block length requirements (12 bytes). If the block length is less than 12 bytes, this is a noise block. Another block should be read and the operation continued. If the noise bit is on or if the block length meets or exceeds the minimum block length requirements, the read operation should be retried using Steps 2 and 3.

Step 2. Set the correct mode (if seven-track) and reposition the tape.

Step 3. Set the correct mode (if seven-track) and re-issue the read or read backward command. *Note:* For program simplicity, the mode set command in this sequence may be issued whether required or not.

Step 4. Repeat steps 2 and 3 until a minimum of forty retries (forty-one reads) have been attempted.

After every fourth reread (step 3) the block-in-error should be passed by the tape cleaner blade.

Note: Tape cleaner positioning for a forward read is five back-spaces followed by four forward spaces. For a backward read it is four back-spaces followed by five forward spaces. During a tape cleaner positioning, if load point is reached in 'n' backspaces, reposition for a read forward with 'n-2' forward spaces; reposition for a read backward with 'n' forward spaces. If a tape mark is encountered during a tape cleaner positioning, the unit exception indication should be ignored, and the tape mark should be treated as a normal block.

Step 6. Should the error persist, execute Action 1a.

Action VIa: Data Check on Write and Write Tape Mark

Reposition the tape, issue an erase gap (ERG) and re-issue the command. Repeat this procedure until nine retries have been attempted. If the error persists, execute Action 1b.

Note: This action is designed for the maximum block length of 4095 bytes at 200 bpi.

Priority	Status Bit	Sense		Condition	Applicable to			Action
		Byte	Bit		Read	Write	Control	
1	10			Program Check*	x	x	x	Ib
2	16			Channel Data Check	x	x	x	Ia
3	14			Unit Check	x	x	x	II
4		0	3	Equipment Check	x	x	x	X
5		0	2	Bus Out Check	x	x	x	IV
6		0	0	Command Reject	x	x	x	Ib
7		0	5	Overrun	x	x		VII
8		1	4	Load Point	x		x	Ib
9		0	6	Word Count Zero	x	x		Ib
10		0	1	Intervention Required	x	x	x	III
11		1	7	Not Capable	x		x	IX
12		0	4	Data Check	x			Va
12		0	4	Data Check		x		VIa
13		0	7	Data Converter Check	x			Ib
14				No Previous Sense Bits On	x	x	x	Ib
15	18			Incorrect Length	x	x		Ib

*Program Check is tested first since the CSW contents are generally unpredictable when it is present on a Model 20.

Figure 41. Status and Sense Indicator (Bits) Checking Sequence – Model 20

Appendix B — 2420 Cartridge and Reel Specifications

OPTIONAL TAPE CARTRIDGE FOR USE WITH THE 2420 MODEL 7 TAPE UNIT

An optional tape cartridge (2420 Wraparound Cartridge) is available, exclusively for use with the 2420 Model 7, for standard IBM 10.5 inch tape reels. Both reel and cartridge are mounted as an integral unit on the 2420 Model 7.

The 2420 Wraparound Cartridge, when used with a solid flanged tape reel, provides a sealed container to help keep tapes free from dust and other contaminants. The use of cartridges results in less reel handling, and, in conjunction with automatic threading, eliminates any physical tape handling. As a result, tape contamination and damage are reduced.

Note 1. To ensure satisfactory automatic threading operation with short or stripped tape reels, the following restriction applies: when using the 2420 Wraparound Cartridge with a 10.5 inch reel, sufficient tape must be remaining on the rewound reel so that the distance between the edge of the reel flange and the outer layer of tape does not exceed 5/8 inch.

Note 2. Tape reels having an 'E' value (distance between flange edge and the outer layer of tape) less than 1/4 inch cannot be expected to automatically thread successfully when used with the 2420 Wraparound Cartridge. Tape reels normally have an 'E' value greater than 1/4 inch; however, out-of-specification tape or special tape reels with extra tape could have too small an 'E' value.

TAPE REEL CONSIDERATIONS FOR 2420 WRAPAROUND CARTRIDGE USE

When a cartridge and its enclosed reel are mounted and operated on the 2420 Model 7, the reel rotates within the opened stationary wraparound cartridge. As a result, reels that have been distorted or warped, damaged from mishandling, or have improper dimensions may not work properly.

To ensure satisfactory operation when using the 2420 Wraparound Cartridge, it is necessary that (1) the reel it will enclose meets the dimensional specifications and envelope limitations shown in Figure 42 under both static and dynamic conditions — (2) the reel is mounted properly on the machine; (3) the reel and cartridge be operated and stored in an environment (see Tape Environment) as recommended for the tape itself and (4) reel and cartridge are physically stored to avoid distortion; i.e., stacked or racked properly. Cracked or damaged reels should never be used.

Tape Environment: Storage Recommendation — The storage conditions of 40° to 90°F and 20% to 80% R.H. with the wet bulb not to exceed 80°F will not cause tape to go out of specification or substantially deteriorate tape drive performance.

Operating Environment — The recommended operating environment for the tape will be 60°F to 90°F and 20% to 80% R.H. with a maximum wet bulb of 78°F.

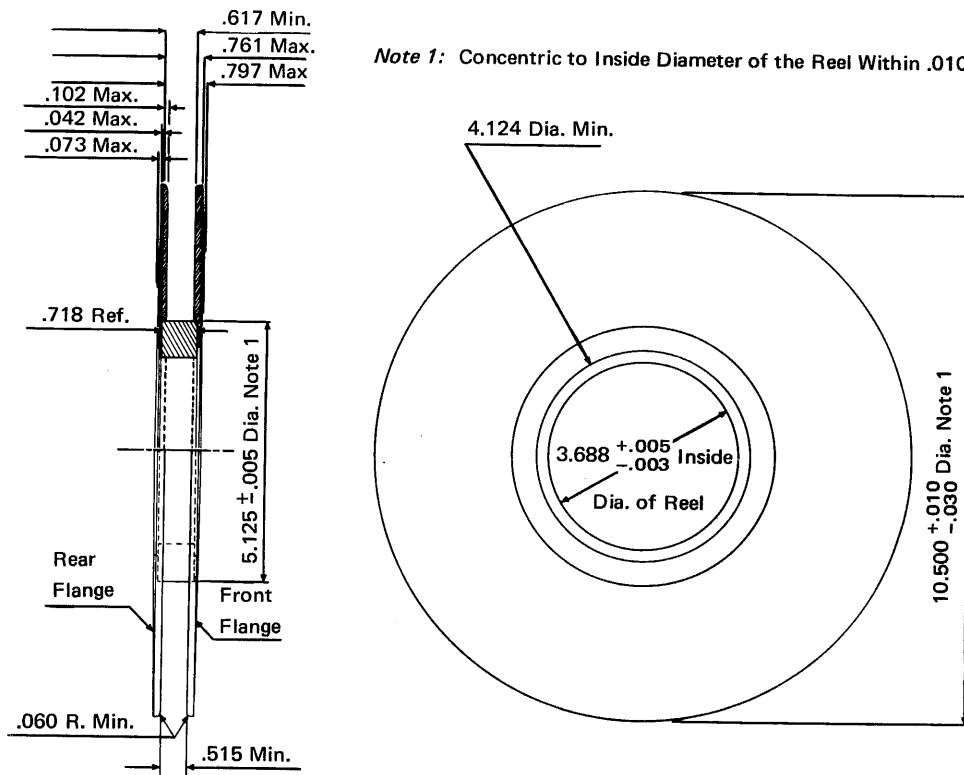

Note: This specification is an addition to the requirements called for in the proposed USASI and EIA one-half inch computer tape reel standards. Any discrepancy between this specification and the standards of the USASI and EIA are overruled by this specification.

Figure 42. Reel Specifications for use in the 2420 Wraparound Cartridge



International Business Machines Corporation
Data Processing Division
112 East Post Road, White Plains, N.Y. 10601
[USA Only]

IBM World Trade Corporation
821 United Nations Plaza, New York, New York 10017
[International]



File Number S360-05

120 MAR 1969

Re:Form No. A22-6866-4

This Newsletter No. N32-0002

Date January 21, 1969

Previous Newsletter Nos. None

ENT'D
11 JULY 1969

**CHANGES TO IBM SYSTEM/360 COMPONENT DESCRIPTION, 2400-SERIES
MAGNETIC TAPE UNITS, 2803/2804 TAPE CONTROLS, AND 2816
SWITCHING UNIT, MODEL 1, FORM A22-6866-4.**

The attached pages contain changes to Error Recovery Procedures (ERPs) and Figure 10. Replace:

- Preface,
- Illustrations List,
- Pages 6, 8
- 49, 50
- 52, 52a
- 54, 55
- Reader's Comment Form

Text changes are marked with a vertical line. Figure changes are marked with a bullet (●). File this newsletter at the back of the manual to provide a record of changes.

INDEX

AC/DC Power Distribution	48	Data Field Conversion Adjustment	20
Address		Data Format	5
Assignment	10	Data Rate	9
Control Unit	10	Density	
Device	10	Recording	9
Tape Unit	10	Setting, Read	22
Attention Status Bit	21	Setting, Write	22
Automatic Error Correction	7	Device End Status Bit	22
Backspace Block (BSB)	13	Disconnect Time	49
Backspace File (BSF)	13	Dual Density Feature	21
BCD Code	15	EBCDIC Code	15
Bits, on Tape	4	End-of-File (EOF)	
Block, Tape	4	(See Tape Mark)	5
Block Length, Minimum		End-of-Tape Marker	4
Read	4	Ending Status	10
Write	4	Envelope Check	7
Block Length, Write and SLI Flag	4	EOF (End-of-File)	
Busy Status Bit	22	(See Tape Mark)	5
Cartridge and Reel, 2420	54	EOT	4
CC (Condition Code)	10	Erase Gap (ERG)	13
Channel End Status Bit	21	Erase Head	3
Channel Status Byte	21	Error Correction	
Channel Status Word (CSW)	11	Automatic	7
Characteristics, Magnetic Tape Unit	10	Programmed	7
Check		Error Correction Procedure, CRC	7
CRC (Cyclic Redundancy Check)	7	Error Recovery Procedures, 2400 Tape	49
Drive and Tape Compatibility	7	General Characteristics	49
Envelope	7	Operation Characteristics	49
LRC (Longitudinal Redundancy Check)	6	Operational Characteristics (Model 20)	49
Multiple Track Error	7	Errors	
Read Back	3	Correction of	7
Skew	7	Recovery Procedures	49
Validity	6	Read	7
VRC (Vertical Redundancy Check)	6	Validity	7
Cleaning Tape	41	Write	7
Code		Features, 2400	
BCD	15	Data Conversion	18
Command	10	Dual Density	21
Control	11	Mode Compatibility	21
EBCDIC	15	Nine-Track (800 bpi NRZI) Compatibility	21
USASCII-8	15	Seven- and Nine-Track (800 bpi NRZI) Compatibility	21
Commands		Seven-Track	15
Control	11	2415 Compatibility Features	21
Mode Set	14	File Protection Device	4
Read	11	Format	
Read Backward	11	Data	5
Sense	15	Command Code	10
Tape Motion	11	Forward Space Block (FSB)	13
Write	11	Forward Space File (FSF)	13
Command Code Format	10	Gap	
Condition Code (CC)	10	Interblock (Interrecord) Gap	5
Control Command	11	Load Point	6
Control Unit End Status Bit	21	Read	3
Converter, Data	18	Tape Mark	6
CRC (Cyclic Redundancy Check)	7	Write	3
CRC Byte (Character)	7	H-Shield	3
CRC Error Correction Procedure	7	Halt I/O	15
CSW (Channel Status Word)	11	Head	
Cyclic Redundancy Check (CRC)	7	Erase	3
Damage Prevention, Tape	40	Read/Write	1
Data Conversion Feature	18		
Data Converter (See Data Conversion Feature)			

I/O Instructions			
Halt I/O	15	Parity Check	
Test I/O	15	(See Vertical Redundancy Check)	6
Immediate Operation	11	PE (Phase Encoding)	4
Information on Tape		Phase Encoding (PE)	4
BCD (Binary Coded Decimal), Seven-Track	15	Power Distribution, AC and DC	
Binary	15	Power Off/Power on – 2400-Series Units	48
EBCDIC (Nine-Track)	15	2401 Magnetic Tape Unit	48
Information, Status	21	2402 Magnetic Tape Unit	48
Initial Selection	10	2403/2404 Magnetic Tape Unit and Control	48
Initial Status	10	Power Window	36
Interblock Gap	5	Procedures, Appendix A	44
Description	5	Programming Aids, Simultaneous Control	29
Timings/Length	50	Protection, Write (See File Protection Device)	
Interlock Switch, Reel Door (See Reel Door Interlock)			
Interrecord Gap		Read Backward Command	11
(See Interblock Gap)		Read Command	11
		Read/Write Head	1
Keys, TU	35	Reading (Sensing)	
		EOT (End-of-Tape)	4
Load Point Marker	4	LP (Load Point)	4
Load Procedure, Tape		Tape	4
2401-2404	44	Tape Markers	13
2415	46	TM (Tape Mark)	13
2420	47	Record	
Logical Data Record (Block)	5	Tape (See Block)	
LRC (Longitudinal Redundancy Check)	6	Tape Library	42
LRC Byte (Character)	6	Recording Density	9
		Recording Method	
Machine Room Housekeeping	49	NRZI (Non-Return-to-Zero IBM)	4
Magnetic Tape		PE (Phase Encoding)	4
Composition	1	Redundancy Checking (See Check)	
Damage Prevention	40	Reel	
Dynexcel	1	File	1
Handling	40	Machine	1
Heavy Duty (HD)	1	Reel Door Interlock Switch	
Markers	1	2401-2404	36
Mylar	1	2415	37
Reel	1	Reel History	42
Reading	1	Reel Release Key	
Retest Service	41	2401-2404	36
Testing	1	2415	37
Track on (Format)	3	Reset Condition	12
Tracks on (Width)	9	Retest Service	41
Writing	1	Rewind and Unload (RUN)	11
Magnetic Tape Unit		Rewind Disconnect Time	49
Characteristics	9	Rewind Time	50
Principles	1	Rewind-Unload Disconnect Time	50
Markers, Reflective	4	Rewind-Unload Time	50
Mode			
Compatibility Feature	21	Sense Byte Interpretation	23-26
Nine-Track	15	Sense Command	15
NRZI Recording	15	Sense Data	
PE Recording	15	Bytes	23-23
Seven-Track	15	Definition	22
Mode Modifier	12	Introduction	11
Mode Set	14	Sense Operation	22
Mode Set Commands	14	Sensing	
Models of 2400 Tape Units	9	(See Reading [Sensing])	
Multiple Track Error Check	7	Seven-Track Feature	15
		Seven- and Nine-Track (800 bpi) NRZI Compatibility Feature	21
Nine-Track (800 bpi) NRZI Compatibility Feature	21	Seven-Track Mode	15
Nine-Track Mode	15	Simultaneous Control	28
Non-Return-to-Zero IBM (NRZI)	4	Simultaneous Control Programming Aids	29
NRZI (Non-Return-to-Zero IBM)	4	Simultaneous Tape Control, 2404/2804	28
		Skew Check	7
Operator Panel		Special Features Configurator, 2401-2404	27
2401-2404	35	Status Byte, Unit	21
2415	36	Status Modifier Status Bit	21
2420	38	“Stripped” Tape, Programming Note	13
2816	33	Switching Unit, 2816 Model 1	32
		Functional Operation	32
		Operator Panel	32

Sync Bytes	5	Tape Record (Block)	5
Tape Block	5	Tape Speed	9
Tape Cleaning	41	Tape Timings, 2400	49
Tape Commands (See Commands)		Tape Transport	
Tape Compatibility	7	Cleaning	45
Tape Error Recovery Procedures	49	2401-2404 Model 1 or 4	44
Tape Feed		2401-2404 Models 2, 3, 5, and 6	45
2401-2404	1	2415 Models 1,6	47
2415	3	Tape Unit Keys and Lights	35
2420	3	Tape Unload Procedure	
Tape Handing and Organization	40	2401-2404	44
Tape Indicate Light		2415	46
2401-2404	36	2420	48
2415	38	Test I/O	15
2420	38	TI (See Tape Indicate)	
Tape Indicate (TI)	4	Time/Byte (Table)	50
Tape Library Records	42	Track Width	9
Tape Load Procedure		Translator	15
2401-2404	44	Transport Cleaning, 2400 Tape Units	45
2415	46	Unit Check Status Bit	22
2420	48	Unit Exception Status Bit	22
Tape Mark	5	Unit Status Byte	21
Tape Markers		Unload Procedure, Tape	
Effect on Program	14	2401-2404	44
End-of-Tape (EOT)	3	2415	46
Load Point (LP)	3	2420	48
Tape Motion Commands		USASCII-8 Code	15
Backspace Block (BSB)	13	Vacuum Column	1
Backspace File (BSF)	13	VRC (Vertical Redundancy Check)	7
Erase Gap (ERG)	13	Write Command	11
Forward Space Block (FSB)	13	Write-Enable Ring (See File Protection Device)	
Forward Space File (FSF)	13	Write Head (See Read/Write Head)	
Rewind and Unload (RUN)	11	Write Protection (See File Protection Device)	
Write Tape Mark (WTM)	13	Write Tape Mark	13
Tape Operation, 2400	10		
Tape Path	3		

READER'S COMMENT FORM

IBM SYSTEM/360 COMPONENT DESCRIPTION

FORM A22-6866-4

- How did you use this publication?

As a reference source

As a classroom text

As

- Based on your own experience, rate this publication ...

As a reference source:

.....
Very	Good	Fair	Poor	Very
Good				Poor

As a text:

.....
Very	Good	Fair	Poor	Very
Good				Poor

- What is your occupation?

- We would appreciate your other comments; please give specific page and line references where appropriate. If you wish a reply, be sure to include your name and address.

● Thank you for your cooperation. No postage necessary if mailed in the U. S. A.

YOUR COMMENTS PLEASE....

Your answers to the questions on the back of this form, together with your comments, will help us produce better publications for your use. Each reply will be carefully reviewed by the persons responsible for writing and publishing this material. All comments and suggestions become the property of IBM.

Please note: Requests for copies of publications and for assistance in utilizing your IBM system should be directed to your IBM representative or to the IBM sales office serving your locality.

fold

fold

FIRST CLASS
PERMIT NO. 568
BOULDER, COLO.

BUSINESS REPLY MAIL
NO POSTAGE NECESSARY IF MAILED IN THE UNITED STATES

POSTAGE WILL BE PAID BY . . .

IBM Corporation
P.O. Box 1900
Boulder, Colorado 80302

ATTENTION: PRODUCT PUBLICATIONS DEPT. 265

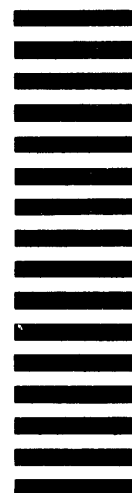

fold

fold



International Business Machines Corporation
Field Engineering Division
112 East Post Road, White Plains, N. Y. 10601